

23 Ray Optics and Optical Instruments

Question: A lens is made up of 3 different transparent media as shown in figure. A point object O is placed on its axis beyond $2f$. How many real images will be obtained on the other side?

NEET 2023 Manipur

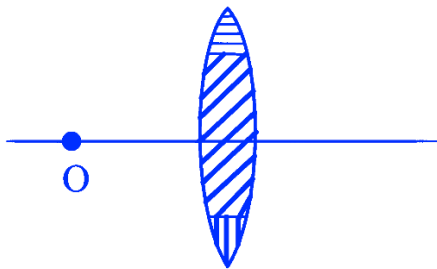

A 2

B 1

C No image will be formed

D 3

Answer: B

Explanation

Since lens is made of three materials so three μ and hence three images.

Question:



ϵ_0 and μ_0 are the electric permittivity and magnetic permeability of free space respectively. If the corresponding quantities of a medium are $2\epsilon_0$ and $1.5\mu_0$ respectively, the refractive index of the medium will nearly be :

NEET 2023 Manipur

A $\sqrt{2}$

B $\sqrt{3}$

C 3

D 2

Answer: B

Explanation

$$\mu = \frac{C}{V} = \frac{\frac{1}{\sqrt{\mu_0\epsilon_0}}}{\frac{1}{\sqrt{1.5\mu_0 \times 2\epsilon_0}}} = \sqrt{3}$$

Question: A horizontal ray of light is incident on the right-angled prism with prism angle 6° . If the refractive index of the material of the prism is 1.5, then the angle of emergence will be:

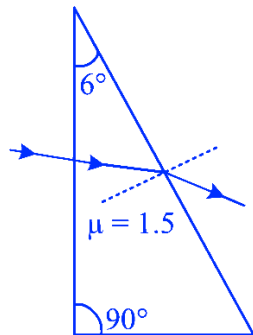

A 9°

B 10°

C 4°

D 6°

Answer: A

Explanation

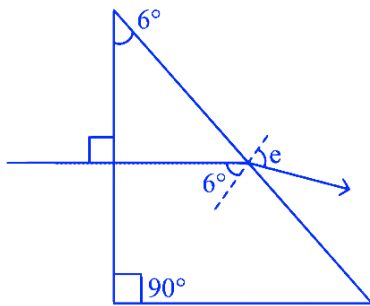

$$A = r_1 + r_2 = 6^\circ$$

$$\mu = 1.5 \frac{\sin e}{\sin r_2} = \frac{\sin e}{\sin 6}$$

$$\sin e = 1.5 \times 6^\circ$$

$$e \simeq 9^\circ$$

Question:

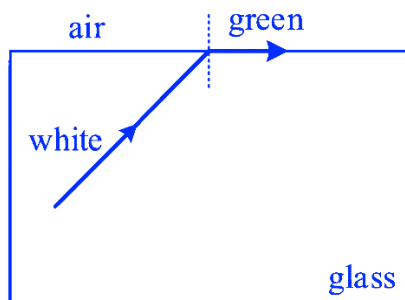

Which set of colors will come out in air for a situation shown in figure?

NEET 2023 Manipur

A Yellow, Orange and Red

B All

C Orange, Red and Violet

D Blue, Green and Yellow

Answer: A

Explanation

$$\sin i_c = \frac{1}{\mu} \propto \lambda$$

$$i_c \propto \lambda$$

Yellow, orange, red emerge from air.

Question: An object is mounted on a wall. Its image of equal size is to be obtained on a parallel wall with the help of a convex lens placed between these walls. The lens is kept at distance x in front of the second wall. The required focal length of the lens will be:

NEET 2023 Manipur

A less than $\frac{x}{4}$

B more than $\frac{x}{4}$ but less than $\frac{x}{2}$

C $\frac{x}{2}$

D $\frac{x}{4}$

Answer: C

Explanation

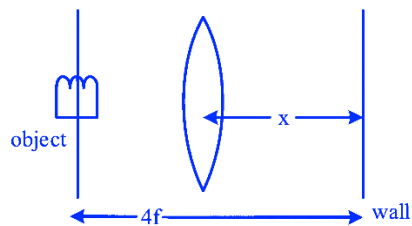

$$x = 2f$$

$$f = x/2$$

Light travels a distance x in time t_1 in air and $10x$ in time t_2 in another denser medium. What is the critical angle for this medium?

A $\sin^{-1} \left(\frac{10t_2}{t_1} \right)$

B $\sin^{-1} \left(\frac{t_1}{10t_2} \right)$

C $\sin^{-1} \left(\frac{10t_1}{t_2} \right)$

D $\sin^{-1} \left(\frac{t_2}{t_1} \right)$

Answer: C

Explanation

Speed of light in air $V_1 = \frac{x}{t_1}$

speed of light in a medium $V_2 = \frac{10x}{t_2}$

$$\sin \theta_c = \frac{V_2}{V_1} = \frac{10x}{t_2} \frac{t_1}{x}$$

$$\theta_c = \sin^{-1} \left(\frac{10t_1}{t_2} \right)$$

Question: For Young's double slit experiment, two statements are given below :

Statement I : If screen is moved away from the plane of slits, angular separation of the fringes remains constant.

Statement II : If the monochromatic source is replaced by another monochromatic source of larger wavelength, the angular separation of fringes decreases.

In the light of the above statements, choose the correct answer from the options given below :

NEET 2023

A Both Statement I and Statement II are false



B Statement I is true but Statement II is false

C Statement I is false but Statement II is true

D Both Statement I and Statement II are true

Answer: B

Explanation

In Young's double slit experiment, the angular separation of the fringes (θ) is given by :

$$\theta = \frac{m\lambda}{d}$$

where m is the fringe order, λ is the wavelength of the light, and d is the distance between the slits.

Now, let's analyze both statements:

Statement I: If the screen is moved away from the plane of the slits, the angular separation of the fringes remains constant.

This statement is true because the angular separation of the fringes (θ) does not depend on the distance between the screen and the slits. It only depends on the fringe order (m), the wavelength of the light (λ), and the distance between the slits (d).

Statement II: If the monochromatic source is replaced by another monochromatic source of larger wavelength, the angular separation of fringes decreases.

This statement is false because if the wavelength (λ) increases, the angular separation of the fringes (θ) also increases according to the formula :

$$\theta = \frac{m\lambda}{d}$$

So, the correct answer is :



Option B: Statement I is true but Statement II is false.

Question: In the figure shown here, what is the equivalent focal length of the combination of lenses (Assume that all layers are thin) ?

NEET 2023

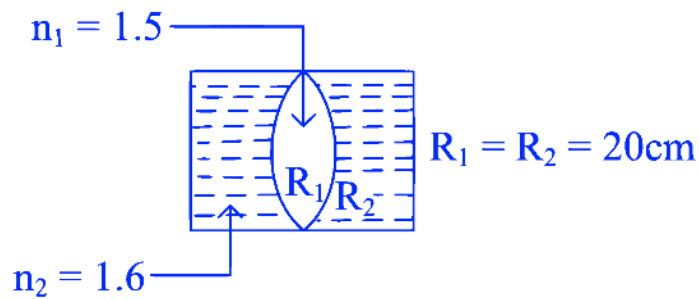

A -40 cm

B -100 cm

C -50 cm

D 40 cm

Answer: B

Explanation

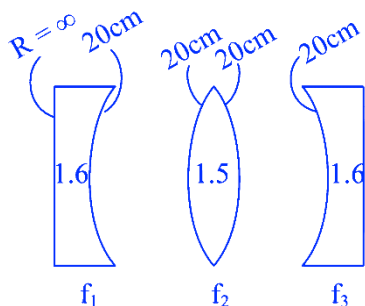

$$\text{Use } \frac{1}{f} = [\mu - 1] \left[\frac{1}{R_1} - \frac{1}{R_2} \right]$$

$$\frac{1}{f_1} = [1.6 - 1] \left[\frac{1}{\infty} - \frac{1}{20} \right] = \frac{-3}{100}$$

$$\frac{1}{f_2} = [1.5 - 1] \left[\frac{1}{20} + \frac{1}{20} \right] = \frac{1}{20}$$

$$\frac{1}{f_3} = \frac{-3}{100}$$

$$\frac{1}{f_{eq}} = \frac{1}{f_1} + \frac{1}{f_2} + \frac{1}{f_3}$$

$$\frac{1}{f_{eq}} = -\frac{3}{100} + \frac{1}{20} - \frac{3}{100} = \frac{-1}{100}$$

Question: Two thin lenses are of same focal lengths (F), but one is convex and the other one is concave. When they are placed in contact with each other, the equivalent focal length of the combination will be :

NEET 2023

A $f/4$

B $f/2$

C Infinite

D Zero

Answer: C

Explanation

$$\frac{1}{f_{eq}} = \frac{1}{f_1} + \frac{1}{f_2}$$

$$\frac{1}{f_{eq}} = \frac{1}{f} - \frac{1}{f}$$

$$f_{eq} = \infty$$

2022

MCQ (Single Correct Answer)

Q.1. During a cloudy day, a primary and a secondary rainbow may be created, then the :

- A secondary rainbow is due to single internal reflection and is formed above the primary one.
- B primary rainbow is due to double internal reflection and is formed above the secondary one.
- C primary rainbow is due to double internal reflection and is formed below the secondary one.
- D secondary rainbow is due to double internal reflection and is formed above the primary one.

NEET 2022 Phase 2

Ans. (D)

Explanation

Primary rainbow is result of three-step process, that is, refraction, internal reflection and refraction.

Secondary rainbow is result of four step process, that is, refraction, internal reflection, internal reflection and refraction.

Secondary rainbow appears above the primary rainbow.

Q.2. If the screen is moved away from the plane of the slits in a Young's double slit experiment, then the :

- A linear separation of the fringes decreases
- B angular separation of the fringes increases



C angular separation of the fringes decreases

D linear separation of the fringes increase

NEET 2022 Phase 2

Ans. (D)

Explanation

In YDSE,

Separation between fringes is

Related to fringed width $\beta = \frac{D\lambda}{d}$

If D is increased β increases while

Angular separation is independent of distance between slits and screen (D)

As angular separation = $\frac{\beta}{D} = \frac{\lambda}{d}$

Q.3. After passing through a polariser a linearly polarised light of intensity I is incident on an analyser making an angle of 30° with that of the polariser. The intensity of light emitted from the analyser will be

A $\frac{2I}{3}$

B $\frac{I}{2}$

C $\frac{I}{3}$

D $\frac{3I}{4}$



Ans. (D)

Explanation

According to Malu's Law

$$I_{out} = I_{in} \cos^2\theta$$

$$I_{out} = I \cos^2(30^\circ)$$

$$I_{out} = \frac{3I}{4}$$

Q.4. An astronomical refracting telescope is being used by an observer to observe planets in normal adjustment. The focal lengths of the objective and eye piece used in the construction of the telescope are 20 m and 2 cm respectively. Consider the following statements about the telescope :

- (a) The distance between the objective and eye piece is 20.02 m
- (b) The magnification of the telescope is (-) 1000
- (c) The image of the planet is erect and diminished
- (d) The aperture of eye piece is smaller than that of objective

The correct statements are :

A (a), (b) and (d)

B (a), (b) and (c)

C (b), (c) and (d)

D (c), (d) and (a)



NEET 2022 Phase 2

Ans. (A)

Explanation

Given $f_0 = 20 \text{ m} = 2000 \text{ cm}$, $f_e = 2 \text{ cm}$

- Distance between objective and eye piece

$$l = f_0 + f_e$$

$$= 20 \text{ m} + 2 \text{ cm} = 20.02 \text{ cm}$$

- Magnification of telescope

$$m = -\frac{f_0}{f_e} = -\frac{2000 \text{ cm}}{2 \text{ cm}} = -1000$$

- Image formed by telescope is inverted.
- Aperture of eye piece is smaller than that of objective.

So, statements (a), (b) and (c) are correct.

Q.5. A biconvex lens has radii of curvature, 20 cm each. If the refractive index of the material of the lens is 1.5, the power of the lens is

A +2 D

B +20 D

C +5 D

D Infinity

NEET 2022 Phase 1



Ans. (C)

Explanation

Power of lens is given by

$$P = \frac{1}{f(m)}$$

$$\frac{1}{f} = (\mu - 1) \left(\frac{1}{R_1} - \frac{1}{R_2} \right)$$

$$\frac{1}{f} = \left\{ \frac{3}{2} - 1 \right\} \left(\frac{1}{20} + \frac{1}{20} \right)$$

$$f = 20 \text{ cm}$$

$$P = \frac{1}{20 \times 10^{-2}}$$

$$= 5 \text{ D}$$

Q.6. In a Young's double slit experiment, a student observes 8 fringes in a certain segment of screen when a monochromatic light of 600 nm wavelength is used. If the wavelength of light is changed to 400 nm, then the number of fringes he would observe in the same region of the screen is

A 6

B 8

C 9

D 12

NEET 2022 Phase 1

Ans. (D)



Explanation

$$\beta = \frac{\lambda D}{d}$$

Let length of segment of screen = l

$$\Rightarrow l = 8\beta_1 = \frac{8\lambda_1 D}{d} \dots (1)$$

$$\text{and } l = n\beta_2 = \frac{n\lambda_2 D}{d} \dots (2)$$

from (1) and (2)

$$8\lambda_1 = n\lambda_2$$

$$8(600 \text{ nm}) = n(400 \text{ nm})$$

$$n = 12$$

Q.7. A light ray falls on a glass surface of refractive index $\sqrt{3}$, at an angle 60° . The angle between the refracted and reflected rays would be

A 30°

B 60°

C 90°

D 120°

NEET 2022 Phase 1

Ans. (C)

Explanation



Given $i = 60^\circ$ and $\mu = \sqrt{3}$

\Rightarrow Here, angle of incidence $\Rightarrow i = \tan^{-1}(\mu)$

Hence, reflected and refracted rays would be perpendicular to each other.

Q.8. When light propagates through a material medium of relative permittivity ϵ_r and relative permeability μ_r , the velocity of light, v is given by (c -velocity of light in vacuum)

A $v = c$

B $v = \sqrt{\frac{\mu_r}{\epsilon_r}}$

C $v = \sqrt{\frac{\epsilon_r}{\mu_r}}$

D $v = \frac{c}{\sqrt{\epsilon_r \mu_r}}$

NEET 2022 Phase 1

Ans. (D)

Explanation

$$v = \frac{1}{\sqrt{\epsilon_m \mu_m}}$$

$$v = \frac{1}{\sqrt{\epsilon_0 \epsilon_r \mu_0 \mu_r}}$$

$$\text{Since } c = \frac{1}{\sqrt{\epsilon_0 \mu_0}}$$

$$\Rightarrow v = \frac{c}{\sqrt{\epsilon_r \mu_r}}$$



Q.9. Two transparent media A and B are separated by a plane boundary. The speed of light in those media are 1.5×10^8 m/s and 2.0×10^8 m/s, respectively. The critical angle for a ray of light for these two media is

A $\sin^{-1}(0.500)$

B $\sin^{-1}(0.750)$

C $\tan^{-1}(0.500)$

D $\tan^{-1}(0.750)$

NEET 2022 Phase 1

Ans. (B)

Explanation

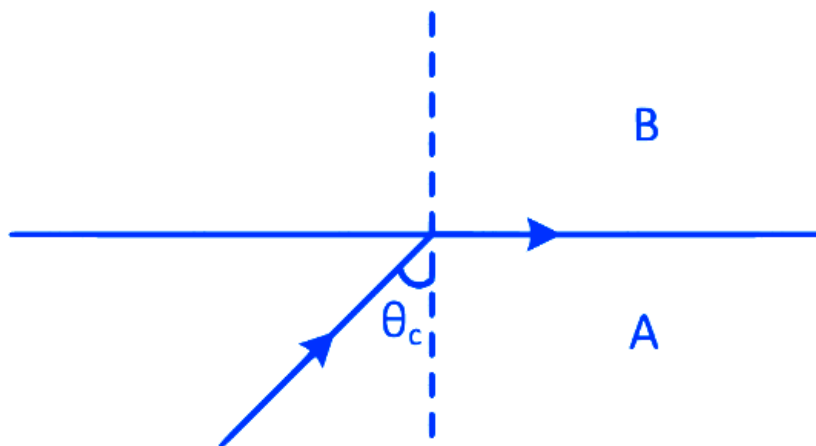

$$\mu_A = \frac{3 \times 10^8}{1.5 \times 10^8} = 2$$

$$\mu_B = \frac{3 \times 10^8}{2 \times 10^8} = 1.5$$

For TIR, ray of light should travel from denser to rarer medium

$$\mu_A \sin \theta_C = \mu_B \sin 90^\circ$$

$$2 \sin \theta_C = 1.5 \sin 90^\circ$$

$$\sin \theta_C = 0.75$$

$$\theta_C = \sin^{-1}(0.75)$$



TOPIC 1

Reflection of Light

- 01** An object is placed on the principal axis of a concave mirror at a distance of $1.5f$ (f is the focal length). The image will be at

[NEET (Oct.) 2020]

- (a) $-3f$ (b) $1.5f$
(c) $-1.5f$ (d) $3f$

Ans. (a)

Object distance, $u = -1.5f$

By mirror formula,

$$\frac{1}{v} + \frac{1}{u} = \frac{1}{f}$$

$$\Rightarrow \frac{1}{v} + \frac{1}{-1.5f} = \frac{1}{-f}$$

$$\Rightarrow \frac{1}{v} = -\frac{1}{f} + \frac{1}{1.5f}$$

$$= \frac{1}{f} \left[-1 + \frac{1}{1.5} \right] = \frac{1}{f} \left[-1 + \frac{2}{3} \right]$$

$$\Rightarrow \frac{1}{v} = \frac{1}{f} \left(-\frac{1}{3} \right)$$

$$\Rightarrow v = -3f$$

- 02** An object is placed at a distance of 40 cm from a concave mirror of focal length 15 cm. If the object is displaced through a distance of 20 cm towards the mirror, the displacement of the image will be

[NEET 2018]

- (a) 30 cm towards the mirror
(b) 36 cm away from the mirror
(c) 30 cm away from the mirror
(d) 36 cm towards the mirror

Ans. (b)

Key Concept The net displacement of the images is equal to the difference between the image distance in both the cases.

Case 1 When the object distance, $u_1 = -40$ cm

Focal length of mirror, $f = -15$ cm

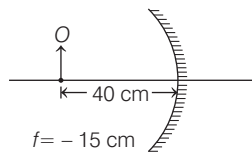

Using the mirror formula, we get

$$\frac{1}{f} = \frac{1}{v_1} + \frac{1}{u_1}$$

Substituting the given values, we get

$$-\frac{1}{15} = \frac{1}{v_1} + \left(\frac{-1}{40} \right)$$

$$\Rightarrow \frac{1}{v_1} = \frac{1}{40} - \frac{1}{15} = \frac{3-8}{120} = \frac{-5}{120}$$

$$\Rightarrow v_1 = \frac{-120}{5} = -24 \text{ cm}$$

Case 2 When the object distance,

$u_2 = 20$ cm

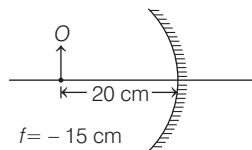

Using the mirror formula, we get

$$\frac{1}{f} = \frac{1}{v_2} + \frac{1}{u_2}$$

$$-\frac{1}{15} = \frac{1}{v_2} + \left(-\frac{1}{20} \right)$$

$$\Rightarrow \frac{1}{v_2} = \frac{1}{20} - \frac{1}{15} = \frac{3-4}{60} = \frac{-1}{60}$$

$$\Rightarrow v_2 = -60 \text{ cm}$$

∴ The displacement of the image is

$$= v_2 - v_1$$

$$= -60 - (-24) = -60 + 24$$

$$\text{or } = -36 \text{ cm}$$

$$= 36 \text{ cm, away from the mirror}$$

- 03** A beam of light from a source L is incident normally on a plane mirror fixed at a certain distance x from the source. The beam is reflected back as a spot on a scale placed just above the source L . When the mirror is rotated through a small angle θ , the spot of the light is found to move through a distance y on the scale. The angle θ is given by

[NEET 2017]

- (a) $\frac{y}{2x}$ (b) $\frac{y}{x}$
(c) $\frac{x}{2y}$ (d) $\frac{x}{y}$

Ans. (a)

According to the question

L = Light source

When the light beams incident normally on the plane mirror, it is reflected back to the point from which it was coming. When the plane mirror is rotated by an angle θ , the reflected ray or beam of light must rotate by angle 2θ , from refraction at plane surface theory.



- 04** Match the corresponding entries of Column 1 with Column 2. [Where m is the magnification produced by the mirror] [NEET 2016]

Column 1	Column 2
A. $m = -2$	a. Convex mirror
B. $m = -\frac{1}{2}$	b. Concave mirror
C. $m = +2$	c. Real image
D. $m = +\frac{1}{2}$	d. Virtual image

- (a) A → a and c; B → a and d; C → a and b; D → c and d
 (b) A → a and d; B → b and c; C → b and d; D → b and c
 (c) A → c and d; B → b and d; C → b and c; D → a and d
 (d) A → b and c; B → b and c; C → b and d; D → a and d

Ans. (d)

A concave mirror forms real and virtual images, whose magnification can be negative or positive depending upon the position of the object.

If object is placed between focus and pole the image obtained will be virtual and its magnification will be positive. In all other cases concave mirror forms real images whose magnification will be negative.

A convex mirror always forms a virtual image whose magnification will always be positive.

- 05** A concave mirror of focal length f_1 is placed at a distance of d from a convex lens of focal length f_2 . A beam of light coming from infinity and falling on this convex lens-concave mirror combination returns to infinity. The distance d must be equal [CBSE AIPMT 2012]

- (a) $f_1 + f_2$ (b) $-f_1 + f_2$
 (c) $2f_1 + f_2$ (d) $-2f_1 + f_2$

Ans. (c)

According to question, the ray diagram will be

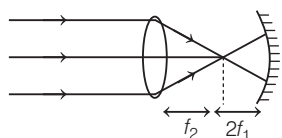

So, distance d between convex lens and concave mirror is given by
 $d = 2f_1 + f_2$

- 06** A man is 6 ft tall. In order to see his entire image, he requires a plane mirror of minimum length equal to [CBSE AIPMT 2000]

- (a) 6 ft (b) 12 ft
 (c) 2 ft (d) 3 ft

Ans. (d)

The minimum size of plane mirror required to see full length of a man

$$= \frac{\text{height of man}}{2}$$

Given, height of man = 6 ft

Thus, minimum size of plane mirror

$$= \frac{6}{2} = 3 \text{ ft}$$

- 07** If two mirrors are kept inclined at 60° to each other and a body is placed at the middle, then total number of images formed, is [CBSE AIPMT 1995]

- (a) six
 (b) five
 (c) four
 (d) three

Ans. (b)

When an object is held in between two plane mirrors M_1 and M_2 inclined at $\angle\theta$, more than one image is formed on account of multiple reflections of light from the mirrors. In general, total number of images (n) formed is given by

$$n = \frac{360^\circ}{\theta} - 1$$

Here, $\theta = 60^\circ$

$$\therefore n = \frac{360^\circ}{60^\circ} - 1 = 6 - 1 = 5$$

- 08** Ray optics is valid, when characteristic dimensions are [CBSE AIPMT 1989]

- (a) of the same order as the wavelength of light
 (b) much smaller than the wavelength of light
 (c) of the order of one millimetre
 (d) much larger than the wavelength of light

Ans. (d)

Ray optics, uses the geometry of straight lines to account for the macroscopic phenomena like rectilinear propagation, reflection, refraction etc. Ray optics can be taken as a limiting case of wave optics. This is primarily because wavelength of light is small.

TOPIC 2

Refraction, TIR and Prism

- 09** Find the value of the angle of emergence from the prism. Refractive index of the glass is $\sqrt{3}$. [NEET 2021]

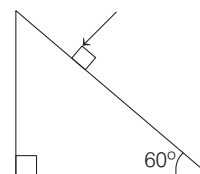

- (a) 60° (b) 30°
 (c) 45° (d) 90°

Ans. (a)

Given, the refractive index of the glass, $n_2 = \sqrt{3}$

The refractive index of the air, $n_1 = 1$

The path of ray incident on the prism is as shown below

From the given figure, $r_1 = 0^\circ$

As, $A = r_1 + r_2$

where, A is the angle of prism.

$$30^\circ = 0^\circ + r_2 \Rightarrow r_2 = 30^\circ$$

Using the Snell's law, in glass and air interference,

$$n_2 \sin \theta_2 = n_1 \sin \theta_1 \Rightarrow$$

$$n_2 \sin r_2 = n_1 \sin e$$

$$\Rightarrow \sqrt{3} \sin 30^\circ = 1 \times \sin e \Rightarrow \sin e = \frac{\sqrt{3}}{2}$$

$$\Rightarrow \sin e = \sin 60^\circ \Rightarrow e = 60^\circ$$

- 10** If the critical angle for total internal reflection from a medium to vacuum is 45° , then velocity of light in the medium is [NEET (Oct.) 2020]

- (a) 1.5×10^8 m/s (b) $\frac{3}{\sqrt{2}} \times 10^8$ m/s
 (c) $\sqrt{2} \times 10^8$ m/s (d) 3×10^8 m/s

Ans. (b)

Critical angle, $i_c = 45^\circ$

We know that,

$$\mu = \frac{1}{\sin i_c} = \frac{1}{\sin 45^\circ} = \frac{1}{1/\sqrt{2}} = \sqrt{2}$$

$$\Rightarrow \mu = \sqrt{2}$$

$$\Rightarrow \frac{\text{Velocity of light in air}}{\text{Velocity of light in medium}} = \sqrt{2}$$

$$\Rightarrow \frac{3 \times 10^8}{v_m} = \sqrt{2}$$

$$\Rightarrow v_m = \frac{3}{\sqrt{2}} \times 10^8 \text{ m/s}$$

- 11** A ray is incident at an angle of incidence i on one surface of a small angle prism (with angle of prism A) and emerges normally from the opposite surface. If the refractive index of the material of the prism is μ , then the angle of incidence is nearly equal to

[NEET (Sep.) 2020]

- (a) $\frac{2A}{\mu}$ (b) μA
 (c) $\frac{\mu A}{2}$ (d) $\frac{A}{2\mu}$

Ans. (b)

According to the question, the ray diagram can be shown as

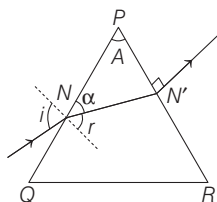

From figure in $\Delta PNN'$,

$$A + \alpha + 90^\circ = 180^\circ$$

$$\Rightarrow \alpha = 90^\circ - A \quad \dots(i)$$

Also, $r + \alpha = 90^\circ$

$$\Rightarrow r = 90^\circ - \alpha = 90^\circ - (90^\circ - A) = A$$

[\because from Eq. (i)]

$$\Rightarrow r = A$$

From Snell's law,

$$\mu_1 \sin i = \mu_2 \sin r$$

$$\Rightarrow \sin i = \mu \sin A$$

(here, $\mu_1 = 1$ and $\mu_2 = \mu$)

For small angle, $\sin \theta \approx \theta$

$$\Rightarrow i = \mu A$$

Hence, correct option is (b).

- 12** Pick the wrong answer in the context with rainbow.

[NEET (National) 2019]

- (a) The order of colours is reversed in the secondary rainbow
 (b) An observer can see a rainbow when his front is towards the sun
 (c) Rainbow is a combined effect of dispersion refraction and reflection of sunlight
 (d) When the light rays undergo two internal reflections in a water drop, a secondary rainbow is formed

Ans. (b)

The necessary conditions for the rainbow to take place is

- (i) Sun should be shining in part of the sky while it is raining in opposite part of the sky.

- (ii) The observer must stand with his back towards the sun.

\therefore Statement in option (b) is wrong.

However, rest statements regarding the rainbow are correct.

- 13** Which colour of the light has the longest wavelength?

[NEET (National) 2019]

- (a) Blue (b) Green
 (c) Violet (d) Red

Ans. (d)

Different colours of white light have different wavelengths. The descending order of the wavelength of the component of white light is

$$\lambda_{\text{Red}} > \lambda_{\text{Green}} > \lambda_{\text{Blue}} > \lambda_{\text{Violet}}$$

- 14** In total internal reflection when the angle of incidence is equal to the critical angle for the pair of media in contact, what will be angle of refraction? [NEET (National) 2019]

- (a) 0°
 (b) Equal to angle of incidence
 (c) 90°
 (d) 180°

Ans. (c)

The total internal reflection is the phenomenon of reflection back of light in the denser medium when it travel from denser to rarer medium, when the angle of incidence is greater than the critical angle. While the critical angle for a pair of given media in contact is the angle of incidence in denser medium for which the angle of refraction in rarer medium is 90° .

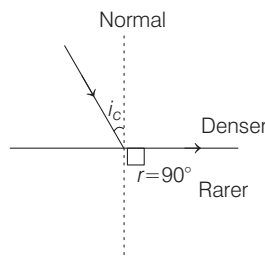

- 15** The refractive index of the material of a prism is $\sqrt{2}$ and the angle of the prism is 30° . One of the two refracting surfaces of the prism is made a mirror inwards, by silver coating. A beam of

monochromatic light entering the prism from the other face will retrace its path (after reflection from the silvered surface) if its angle of incidence on the prism is

[NEET 2018]

- (a) 30° (b) 45° (c) 60° (d) zero

Ans. (b)

According to the question, the figure of mentioned prism is given as

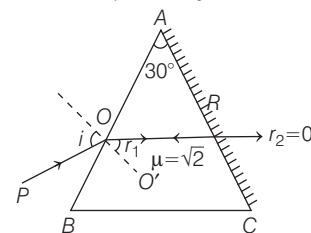

(since, there is no refraction at the face AC)

Given,

Refractive index of the material of prism, $\mu = \sqrt{2}$

Angle of prism, $A = 30^\circ$

If the ray OR has to retrace its path after reflection (as per the given condition), then the ray has to fall normally on the surface AC .

This means

$$\angle ARO = \angle ORC = 90^\circ$$

In ΔAOR ,

$$\angle AOR + \angle ARO + \angle OAR = 180^\circ$$

$$\Rightarrow \angle AOR + 90^\circ + 30^\circ = 180^\circ$$

$$\Rightarrow \angle AOR = 180^\circ - 120^\circ = 60^\circ \quad \dots(i)$$

As we know,

$$\angle AOR + \angle r_1 = 90^\circ$$

$$\Rightarrow \angle r_1 = 90^\circ - 60^\circ = 30^\circ \quad [\text{from Eq. (i)}]$$

Applying Snell's law at the face AB , we get

$$\mu = \frac{\sin i}{\sin r_1}$$

Substituting the given values, we get

$$\sqrt{2} = \frac{\sin i}{\sin 30^\circ}$$

$$\Rightarrow \sin i = \sin 30^\circ \times \sqrt{2}$$

$$= \frac{1}{2} \times (\sqrt{2} \sin 30^\circ = \frac{1}{2})$$

$$= \frac{1}{\sqrt{2}}$$

$$\text{or } i = \sin^{-1}\left(\frac{1}{\sqrt{2}}\right)$$

$$= 45^\circ \quad \left(\because \sin 45^\circ = \frac{1}{\sqrt{2}}\right)$$

The angle of incidence of the ray on the prism is 45° .

- 16** A thin prism having refracting angle 10° is made of glass of refractive index 1.42. This prism is combined with another thin prism of glass of refractive index 1.7. This combination produces dispersion without deviation. The refracting angle of second prism should be

[NEET 2017]

- (a) 4° (b) 6° (c) 8° (d) 10°

Ans. (b)

Thinking Process For dispersion without deviation, net deviation produced by the combination of prisms must be zero.

Let, prism angle of the first and second prisms are A_1 and A_2 respectively. Similarly, their refractive indices are μ_1 and μ_2 .

Condition for dispersion without deviation is

$$\delta_1 - \delta_2 = 0$$

$$\Rightarrow (\mu_1 - 1) A_1 - (\mu_2 - 1) A_2 = 0$$

$$\Rightarrow A_2 = \left(\frac{\mu_1 - 1}{\mu_2 - 1} \right) A_1$$

$$A_2 = \left(\frac{1.42 - 1}{1.7 - 1} \right) (10^\circ) \Rightarrow A_2 = 6^\circ$$

- 17** The angle of incidence for a ray of light at a refracting surface of a prism is 45° . The angle of prism is 60° . If the ray suffers minimum deviation through the prism, the angle of minimum deviation and refractive index of the material of the prism respectively, are

[NEET 2016]

- (a) $30^\circ; \sqrt{2}$ (b) $45^\circ; \sqrt{2}$
(c) $30^\circ; \frac{1}{\sqrt{2}}$ (d) $45^\circ; \frac{1}{\sqrt{2}}$

Ans. (a)

Consider a ray of light PQ incident on the surface AB and moves along RS , after passing through the prism ABC .

It is given that the incident ray suffers minimum deviation. Therefore, the ray inside the prism must be parallel to the base BC of the prism.

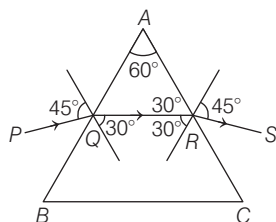

From the geometry of the prism and the ray diagram, it is clear that angle of incidence, $i = 45^\circ$
angle of refraction $r = r' = 30^\circ$
angle of emergence, $e = 45^\circ$
Therefore, minimum deviation suffered by the ray is

$$\delta_{\min} = i + e - (r + r')$$

$$= 90^\circ - 60^\circ = 30^\circ$$

Also we know that

$$\mu = \frac{\sin\left(\frac{A + \delta_m}{2}\right)}{\sin\frac{A}{2}}$$

where, μ = refractive index of the material of the prism.

A = angle of prism = 60°

$$\therefore \mu = \frac{\sin\left(\frac{60^\circ + 30^\circ}{2}\right)}{\sin\frac{60^\circ}{2}} = \frac{\sin 45^\circ}{\sin 30^\circ}$$

$$= \frac{1/\sqrt{2}}{1/2} = \frac{2}{\sqrt{2}} = \sqrt{2}$$

- 18** An air bubble in a glass slab with refractive index 1.5 (near normal incidence) is 5 cm deep when viewed from one surface and 3 cm deep when viewed from the opposite face. The thickness (in cm) of the slab is [NEET 2016]

- (a) 8 (b) 10
(c) 12 (d) 16

Ans. (c)

Let thickness of the given slab is t . According to the question, when viewed from both the surfaces

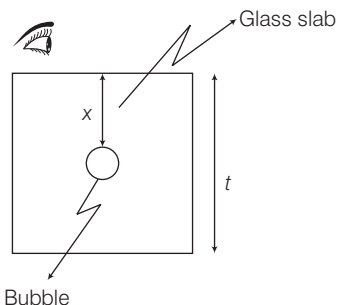

$$\frac{x}{\mu} + \frac{t-x}{\mu} = 3 + 5$$

$$\Rightarrow \frac{t}{\mu} = 8 \text{ cm}$$

$$\Rightarrow t = 8 \times \mu$$

$$\Rightarrow t = 8 \times \frac{3}{2} = 12 \text{ cm}$$

- 19** The refracting angle of a prism is A , and refractive index of the material of the prism is $\cot(A/2)$. The angle of minimum deviation is

[CBSE AIPMT 2015]

- (a) $180^\circ - 3A$ (b) $180^\circ - 2A$
(c) $90^\circ - A$ (d) $180^\circ + 2A$

Ans. (b)

$$\text{As, we know that } \mu = \frac{\sin\left(\frac{A + D_m}{2}\right)}{\sin\frac{A}{2}}$$

$$\Rightarrow \cot\frac{A}{2} = \frac{\sin\left(\frac{A + D_m}{2}\right)}{\sin\frac{A}{2}}$$

$$\Rightarrow \frac{\cos\frac{A}{2}}{\sin\frac{A}{2}} = \frac{\sin\left(\frac{A + D_m}{2}\right)}{\sin\frac{A}{2}}$$

$$\sin\left(\frac{\pi}{2} - \frac{A}{2}\right) = \sin\left(\frac{A + D_m}{2}\right)$$

$$\Rightarrow \frac{\pi}{2} - \frac{A}{2} = \frac{A + D_m}{2}$$

$$\Rightarrow D_m = \pi - 2A$$

$$D_m = 180^\circ - 2A$$

- 20** A beam of light consisting of red, green and blue colours is incident on a right angled prism. The refractive index of the material of the prism for the above red, green and blue wavelengths are 1.39, 1.44 and 1.47, respectively.

[CBSE AIPMT 2015]

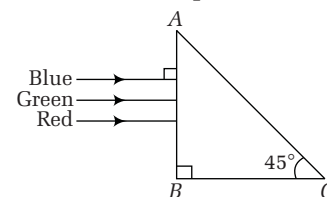

The prism will

- (a) separate the blue colour part from the red and green colours
(b) separate all the three colours from one another
(c) not separate the three colours at all
(d) separate the red colour part from the green and blue colours

Ans. (d)

For refractive index of a index,

$$\mu = \frac{1}{\sin i_c} = \frac{1}{\sin 45^\circ} = \sqrt{2}$$

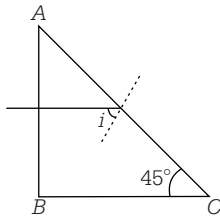

As, $\mu_{\text{red}} = 1.39, \mu_{\text{green}} = 1.44$
 and $\mu_{\text{blue}} = 1.47$
 $\therefore (\mu_{\text{red}} = 1.39) < \mu_{\text{green}} > \mu_{\text{blue}} > \mu$
 Thus, only red colour do not suffer total internal reflection.

21 The angle of a prism is A . One of its refracting surfaces is silvered. Light rays falling at an angle of incidence $2A$ on the first surface returns back through the same path after suffering reflection at the silvered surface. The refractive index μ , of the prism is [CBSE AIPMT 2014]

- (a) $2 \sin A$ (b) $2 \cos A$
 (c) $\frac{1}{2} \cos A$ (d) $\tan A$

Ans. (b)

According to question, diagram is shown below.

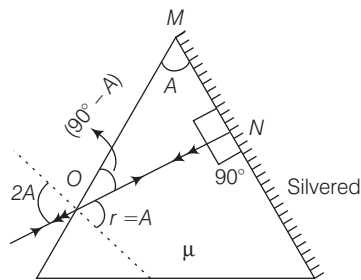

So, $\angle MON = 90^\circ - A$
 and $\angle r = 90^\circ - (90^\circ - A)$
 $\Rightarrow \angle r = A$

By Snell's law, $\frac{\sin i}{\sin r} = \mu$

$$\frac{\sin(2A)}{\sin(A)} = \mu$$

$$\frac{2 \sin A \cos A}{\sin A} = \mu$$

$$\Rightarrow \mu = 2 \cos A$$

22 A ray of light is incident at an angle of incidence, i , on one face of a prism of angle A (assumed to be small) and emerges normally from the opposite face. If the

refractive index of the prism is μ , the angle of incidence i , is nearly equal to [CBSE AIPMT 2012]

- (a) μA (b) $\frac{\mu A}{2}$
 (c) A/μ (d) $A/2\mu$

Ans. (a)

Refractive index

$$\mu = \frac{\sin i}{\sin r}, \mu = \frac{\sin i}{\sin A}$$

In case of small angle, $\sin i \approx i$ and $\sin A \approx A$

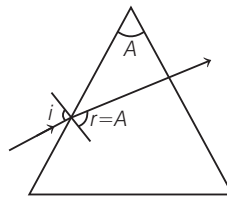

$$\mu = \frac{i}{A}$$

$$i = \mu A$$

23 Which of the following is not due to total internal reflection?

- (a) Difference between apparent and real depth of a pond
 (b) Mirage on hot summer days
 (c) Brilliance of diamond
 (d) Working of optical fibre

Ans. (a)

Real and apparent depth are explained on the basis of refraction only. The concept of TIR is not involved here.

24 A ray of light travelling in a transparent medium of refractive index μ falls, on a surface separating the medium from air at an angle of incidence of 45° . For which of the following value of μ the ray can undergo total internal reflection? [CBSE AIPMT 2010]

- (a) $\mu = 1.33$ (b) $\mu = 1.40$
 (c) $\mu = 1.50$ (d) $\mu = 1.25$

Ans. (c)

For total internal reflection, $i > c$ (critical angle)

So, $\sin i > \sin c$

$$\Rightarrow \sin 45^\circ > \frac{1}{\mu}$$

$$\Rightarrow \mu > \sqrt{2}$$

$$\Rightarrow \mu > 1.4$$

25 The frequency of a light wave in a material is 2×10^{14} Hz and wavelength is 5000 \AA . The refractive index of material will be [CBSE AIPMT 2007]

- (a) 1.40 (b) 1.50 (c) 3.00 (d) 1.33

Ans. (c)

Velocity of light waves in material is

$$v = v\lambda \quad \dots(i)$$

Refractive index of material is

$$\mu = \frac{c}{v} \quad \dots(ii)$$

where, c is speed of light in vacuum or air.

$$\text{or } \mu = \frac{c}{v\lambda} \quad \dots(iii)$$

Given, $v = 2 \times 10^{14}$ Hz

$$\lambda = 5000 \text{ \AA} = 5000 \times 10^{-10} \text{ m}$$

and $c = 3 \times 10^8$ m/s

Hence, from Eq. (iii), we get

$$\mu = \frac{3 \times 10^8}{2 \times 10^{14} \times 5000 \times 10^{-10}} = 3.00$$

26 A small coin is resting on the bottom of a beaker filled with a liquid. A ray of light from the coin travels upto the surface of the liquid and moves along its surface (see figure).

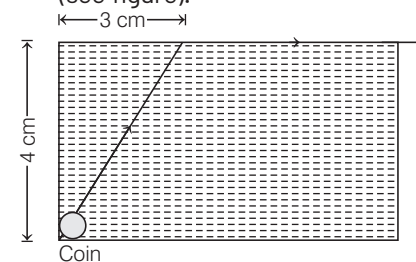

How fast is the light travelling in the liquid? [CBSE AIPMT 2007]

- (a) 1.8×10^8 m/s (b) 2.4×10^8 m/s
 (c) 3.0×10^8 m/s (d) 1.2×10^4 m/s

Ans. (a)

As shown in figure, a light ray from the coin will not emerge out of liquid, if $i > c$.

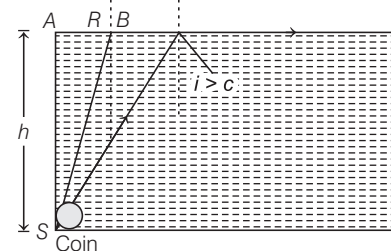

Therefore, minimum radius R corresponds to $i = C$. In ΔSAB ,

$$\frac{R}{h} = \tan C$$

or $R = h \tan C$

or $R = \frac{h}{\sqrt{\mu^2 - 1}}$

Given, $R = 3 \text{ cm}$, $h = 4 \text{ cm}$

Hence, $\frac{3}{4} = \frac{1}{\sqrt{\mu^2 - 1}}$

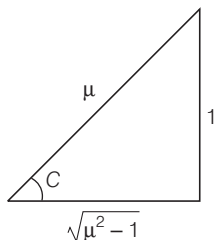

or $\mu^2 = \frac{25}{9}$ or $\mu = \frac{5}{3}$

But $\mu = \frac{c}{v}$ or $v = \frac{c}{\mu}$
 $= \frac{3 \times 10^8}{5/3}$
 $= 1.8 \times 10^8 \text{ m/s}$

27 The refractive index of the material of a prism is $\sqrt{2}$ and its refracting angle is 30° . One of the refracting surfaces of the prism is made a mirror inwards. A beam of monochromatic light entering the prism from the other face will retrace its path after reflection from the mirrored surface, if its angle of incidence on the prism is

[CBSE AIPMT 2004]

- (a) 45° (b) 60°
 (c) 0° (d) 30°

Ans. (a)

According to the given condition, the beam of light will retrace its path after reflection from BC.

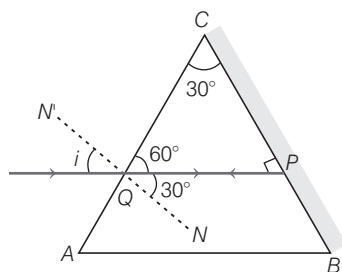

So, $\angle CPQ = 90^\circ$
 Thus, angle of refraction at surface AC

$\angle PQN = \angle r = 90^\circ - 60^\circ = 30^\circ$
 By Snell's law
 $\mu = \frac{\sin i}{\sin r} \Rightarrow \sqrt{2} = \frac{\sin i}{\sin 30^\circ}$

$\therefore \sqrt{2} \times \sin 30^\circ = \sin i$

$\Rightarrow \sqrt{2} \times \frac{1}{2} = \sin i$

$\Rightarrow \sin i = \frac{1}{\sqrt{2}} = \sin 45^\circ$

$\therefore i = 45^\circ$

28 A beam of light composed of red and green rays is incident obliquely at a point on the face of a rectangular glass slab. When coming out on the opposite parallel face, the red and green rays emerge from [CBSE AIPMT 2004]

- (a) two points propagating in two different non-parallel directions
 (b) two points propagating in two different parallel directions
 (c) one point propagating in two different directions
 (d) one point propagating in the same direction

Ans. (b)

In any medium other than air or vacuum, the velocities of different colours are different. Therefore, both red and green colours are refracted at different angles of refraction. Hence, after emerging from glass slab through opposite parallel face, they appear at two different points and move in the two different parallel directions.

29 For the given incident ray as shown in figure, the condition of total internal reflection of the ray will be satisfied if the refractive index of block will be [CBSE AIPMT 2002]

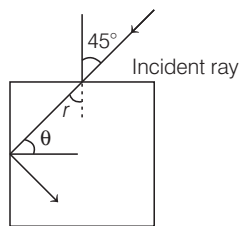

(a) $\frac{\sqrt{3} + 1}{2}$

(b) $\frac{\sqrt{2} + 1}{2}$

(c) $\sqrt{\frac{3}{2}}$

(d) $\sqrt{\frac{7}{6}}$

Ans. (c)

For total internal reflection to take place,

angle of incidence $>$ critical angle

i.e. $\theta > C$

or $\sin \theta > \sin C$

But for the case of total internal reflection,

$$\sin C = \frac{1}{\mu}$$

and according to question

$$\theta = 90^\circ - r$$

So, $\sin(90^\circ - r) > \frac{1}{\mu}$

i.e. $\mu > \frac{1}{\cos r}$

$$[\because \sin(90 - r) = \cos r] \dots (i)$$

From Snell's law,

$$\frac{\sin 45^\circ}{\sin r} = \mu \Rightarrow \sin r = \frac{1}{\sqrt{2}\mu}$$

$$\therefore \cos r = \sqrt{1 - \sin^2 r} = \sqrt{1 - \frac{1}{2\mu^2}}$$

Thus, Eq. (i) becomes

$$\mu > \frac{1}{\sqrt{1 - \frac{1}{2\mu^2}}}$$

$$\therefore \mu^2 = \frac{1}{1 - \frac{1}{2\mu^2}}$$

or $\mu^2 - \frac{1}{2} = 1$ or $\mu = \sqrt{\frac{3}{2}}$

30 Transmission of light in optical fibre is due to [CBSE AIPMT 2001]

- (a) scattering
 (b) diffraction
 (c) polarisation
 (d) multiple total internal reflections

Ans. (d)

An optical fibre is a device based on total internal reflection by which a light signal can be transferred from one place to the other with a negligible loss of energy.

It consists of a very long and thin fibre of quartz glass.

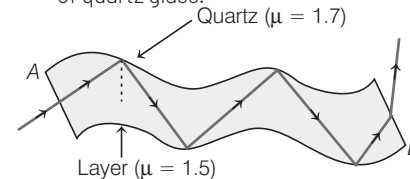

When a light ray is incident at one end of fibre making a small angle of incidence. It suffers multiple total internal reflections and finally it reaches the point B.

- 31** A transparent cube contains a small air bubble. Its apparent distance is 2 cm when seen through one face and 5 cm when seen through other face. If the refractive index of the material of the cube is 1.5, the real length of the edge of cube must be

[CBSE AIPMT 2000]

- (a) 7 cm (b) 7.5 cm
(c) 10.5 cm (d) $\frac{14}{3}$ cm

Ans. (c)

As light travels from denser to rarer medium, so

$$\text{refractive index } (\mu) = \frac{\text{real depth}}{\text{apparent depth}}$$

$$\text{Refractive index } (\mu) = 1.5$$

$$\text{Net apparent depth} = 2 + 5 = 7 \text{ cm}$$

$$\text{And real depth} = \text{apparent depth} \times \mu$$

$$\therefore \text{Real depth} = 1.5 \times 7 = 10.5 \text{ cm}$$

- 32** Rainbows are formed by

[CBSE AIPMT 2000]

- (a) reflection and diffraction
(b) refraction and scattering
(c) dispersion and total internal reflection
(d) interference only

Ans. (c)

When white light from sun falls on raindrops, sometimes a band of different colours in form of a circular arc is seen in the sky. This is called the rainbow.

The reason of origin of rainbow is that the small drops of water behave like a prism for the white sunlight due to which refraction, dispersion and total internal reflection of white light occurs from the water drops.

The rainbow is not seen after every rain, but is seen only when the light rays of particular colour suffer minimum deviation after one or two total internal reflections inside the small water drops.

- 33** The refractive index of the material of the prism is $\sqrt{3}$, then the angle of minimum deviation of the prism is [CBSE AIPMT 1999]

- (a) 30° (b) 45° (c) 60° (d) 75°

Ans. (c)

The refractive index of material of prism (from Snell's law) is

$$\mu = \frac{\sin i}{\sin r}$$

$$\text{Here, } i = \frac{A + \delta_m}{2} \text{ and } r = \frac{A}{2}$$

where, A is the angle of prism and δ_m the angle of minimum deviation.

In case of minimum deviation, refractive index of prism is given by

$$\mu = \frac{\sin\left(\frac{A + \delta_m}{2}\right)}{\sin\frac{A}{2}}$$

$$\text{Given, } \mu = \sqrt{3}, A = 60^\circ \quad (\text{for prism})$$

$$\text{Thus, } \sqrt{3} = \frac{\sin\left(\frac{60 + \delta_m}{2}\right)}{\sin 30^\circ}$$

$$\text{or } \sin\left(\frac{60 + \delta_m}{2}\right) = \frac{1}{2} \times \sqrt{3}$$

$$\text{or } \sin\left(\frac{60 + \delta_m}{2}\right) = \sin 60^\circ$$

$$\text{or } \frac{60 + \delta_m}{2} = 60$$

$$\text{or } \delta_m = 2 \times 60 - 60 = 60^\circ$$

- 34** Light enters at an angle of incidence in a transparent rod of refractive index μ . For what value of the refractive index of the material of the rod the light once entered into it will not leave it through its lateral face whatsoever be the value of angle of incidence? [CBSE AIPMT 1998]

- (a) $\mu > \sqrt{2}$ (b) $\mu = 1$
(c) $\mu = 1.1$ (d) $\mu = 1.3$

Ans. (a)

Suppose a light ray enters at A and refracted beam is AB . At the lateral face, the angle of incidence is θ . For no refraction at this face, $\theta > C$

$$\sin \theta > \sin C$$

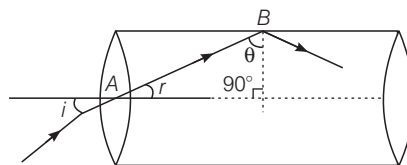

$$\text{but } \theta + r = 90^\circ$$

(According to geometry of figure)

$$\Rightarrow \theta = (90^\circ - r)$$

$$\therefore \sin(90^\circ - r) > \sin C$$

$$\text{or } \cos r > \sin C \quad \dots(i)$$

Now from Snell's law,

$$\mu = \frac{\sin i}{\sin r} \Rightarrow \sin r = \frac{\sin i}{\mu}$$

As from trigonometry,

$$\cos r = \sqrt{1 - \sin^2 r}$$

$$\therefore \cos r = \sqrt{1 - \frac{\sin^2 i}{\mu^2}}$$

\therefore Eq. (i) gives,

$$\sqrt{1 - \frac{\sin^2 i}{\mu^2}} > \sin C$$

$$\Rightarrow 1 - \frac{\sin^2 i}{\mu^2} > \sin^2 C$$

$$\text{Also } \sin C = \frac{1}{\mu}$$

$$\therefore 1 - \frac{\sin^2 i}{\mu^2} > \frac{1}{\mu^2}$$

$$\text{or } 1 > \frac{1}{\mu^2} + \frac{\sin^2 i}{\mu^2}$$

$$\text{or } \frac{1}{\mu^2} (\sin^2 i + 1) < 1$$

$$\text{or } \mu^2 > \sin^2 i + 1$$

The maximum value of $\sin i$ is 1. So,

$$\therefore \mu^2 > 2 \text{ or } \mu > \sqrt{2}$$

- 35** Electromagnetic radiation of frequency ν , velocity v and wavelength λ , in air, enters a glass slab of refractive index μ . The frequency, wavelength and velocity of light in the glass slab will be, respectively

[CBSE AIPMT 1997]

- (a) $\frac{v}{\mu}, \frac{\lambda}{\mu}, \frac{v}{\mu}$ (b) $\nu, \lambda, \frac{v}{\mu}$
(c) $\nu, \frac{\lambda}{\mu}, \frac{v}{\mu}$ (d) $\frac{\nu}{\mu}, \frac{\lambda}{\mu}, \frac{v}{\mu}$

Ans. (c)

When electromagnetic wave enters in other medium, frequency remains unchanged while wavelength and velocity become $\frac{1}{\mu}$ times.

So, after entering from air to glass slab of refractive index (μ), frequency remains ν , wavelength $\lambda' = \frac{\lambda}{\mu}$ and

$$\text{velocity of light } v' = \frac{v}{\mu}$$

- 36** If f_v and f_r are the focal lengths of a convex lens for violet and red light respectively and F_v and F_r are the focal lengths of concave lens for violet and red light respectively, then we have

[CBSE AIPMT 1996]

- (a) $f_v < f_r$ and $F_v > F_r$
(b) $f_v < f_r$ and $F_v < F_r$
(c) $f_v > f_r$ and $F_v > F_r$
(d) $f_v > f_r$ and $F_v < F_r$

Ans. (a)

According to Cauchy relation,

$$\mu = A + \frac{B}{\lambda^2} + \frac{C}{\lambda^4} + \dots \Rightarrow \mu \propto \frac{1}{\lambda}$$

Hence, focal length $f \propto \lambda$

For a convex lens, $f_R > f_V$ or $f_V < f_R$.

For a concave lens, focal length is negative.

So, focal length of concave lens for violet light

$F_V > F_R$ Focal length of concave lens for red light F_R .

- 37** One face of a rectangular glass plate 6 cm thick is silvered. An object held 8 cm in front of the first face, forms an image 12 cm behind the silvered face. The refractive index of the glass is **[CBSE AIPMT 1996]**

(a) 0.4 (b) 0.8 (c) 1.2 (d) 1.6

Ans. (c)

Given,

Thickness of rectangular glass plate (t) = 6 cm

Distance of the object (u) = 8 cm

Distance of the image (v) = 12 cm

Let y = apparent position of the silvered surface.

From property of mirror,

Image distance of object from the mirror

= distance of image from the mirror

i.e. $y + 8 = 12 + 6 - y$

$\therefore y = 5$ cm

$\therefore \mu = \frac{\text{real depth}}{\text{apparent depth}} = \frac{6}{5} = 1.2$

- 38** Light travels through a glass plate of thickness t and refractive index μ . If c is the speed of light in vacuum, the time taken by light to travel this thickness of glass is **[CBSE AIPMT 1996]**

(a) $\mu t c$ (b) $\frac{t c}{\mu}$
(c) $\frac{1}{\mu t}$ (d) $\frac{\mu t}{c}$

Ans. (d)

Here, total thickness = t

Refractive index = μ

Speed of light in glass plate = $\frac{c}{\mu}$

$$\left[\therefore v = \frac{\text{speed of light in vacuum}}{\text{refractive index of medium}} \right]$$

\therefore Time taken by light to travel this thickness of glass

$$= \frac{t}{\left(\frac{c}{\mu}\right)} = \frac{\mu t}{c}$$

- 39.** An achromatic combination of lenses is formed by joining **[CBSE AIPMT 1995]**

(a) 2 convex lenses
(b) 2 concave lenses
(c) 1 convex, 1 concave lens
(d) 1 convex and 1 plane mirror

Ans. (c)

When two or more lenses are combined together in such a way that the combination is free from chromatic aberration, then such a combination is called achromatic combination of lenses. For this purpose, one lens should be convex and other a concave lens.

- 40** Angle of deviation (δ) by a prism (refractive index = μ , and supposing the angle of prism A to be small) can be given by **[CBSE AIPMT 1994]**

(a) $\delta = (\mu - 1) A$ (b) $\delta = (\mu + 1) A$

(c) $\delta = \frac{\sin \frac{A + \delta}{2}}{\sin \frac{A}{2}}$ (d) $\delta = \frac{\mu - 1}{\mu + 1} A$

Ans. (a)

When refracting angle of a prism is small ($< 10^\circ$), the deviation δ is calculated from the relation $\delta = (\mu - 1) A$. For prisms with bigger refracting angles, we use the relation

$$\delta = (i_1 + i_2) - A$$

- 41** A point source of light is placed 4 m below the surface of water of refractive index $\frac{5}{3}$. The minimum

diameter of a disc, which should be placed over the source, on the surface of water to cut off all light coming out of water is **[CBSE AIPMT 1994]**

(a) infinite (b) 6 m
(c) 4 m (d) 3 m

Ans. (b)

In figure, O is the point source of light, K is centre of disc of radius r , $OK = h$. The source will not be seen at all when the height is such that $\angle KOL = C$. (i.e. critical angle between water and air.)

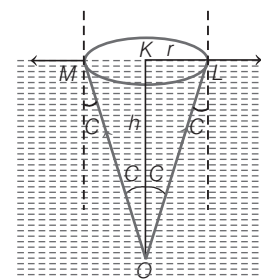

From figure,

$$\sin C = \frac{KL}{OL} = \frac{r}{\sqrt{r^2 + h^2}}$$

For total internal reflection of light,

$$\sin C = \frac{1}{\mu} = \frac{r}{\sqrt{r^2 + h^2}}$$

$\therefore r^2 + h^2 = \mu^2 r^2$

or $h^2 = r^2 (\mu^2 - 1)$

Given, $h = 4$ m, $\mu = \frac{5}{3}$

or $r^2 = \frac{h^2}{\mu^2 - 1} = \frac{(4)^2}{\left(\frac{5}{3}\right)^2 - 1}$

So, $r^2 = 9$

$\therefore r = 3$ m

\therefore Diameter of disc = $2r = 6$ m

- 42** Time taken by sunlight to pass through a window of thickness 4 mm whose refractive index is $\frac{3}{2}$

is **[CBSE AIPMT 1993]**

(a) 2×10^{-4} s (b) 2×10^8 s
(c) 2×10^{-11} s (d) 2×10^{11} s

Ans. (c)

Let x be thickness of window, v be velocity of light entering in window, so time taken by sunlight to pass through the window.

$$t = \frac{x}{v} = \frac{x}{\frac{c}{\mu}} = \frac{\mu x}{c} \quad \left[v = \frac{c}{\mu} \right]$$

$\therefore t = \frac{1.5 \times 4 \times 10^{-3}}{3 \times 10^8} = 2 \times 10^{-11}$ s

- 43** There is a prism with refractive index equal to $\sqrt{2}$ and the refracting angle equal to 30° . One of the refracting surface of the prism is polished. A beam of monochromatic will retrace its path if its angle of incidence over the refracting surface of the prism is **[CBSE AIPMT 1992]**
- (a) 0° (b) 30°
(c) 45° (d) 60°

Ans. (c)

The ray QR will retrace its path, when

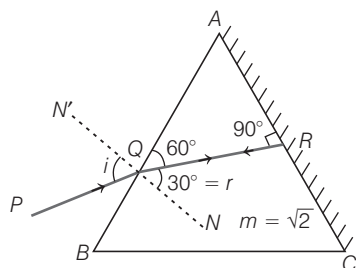

$$\angle ARQ = 90^\circ, \angle R = 30^\circ$$

$$\therefore \angle AQR = 90^\circ - 30^\circ = 60^\circ$$

As from Snell's law,

$$\sin i \times 1 = \sin r \times \mu$$

$$\sin i = \mu \sin r = \sqrt{2} \sin 30^\circ$$

[Refractive index of air = 1]

$$= \sqrt{2} \times \frac{1}{2} = \frac{1}{\sqrt{2}}$$

$$\therefore \angle i = 45^\circ$$

- 44** A beam of monochromatic light is refracted from vacuum into a medium of refractive index 1.5. The wavelength of refracted light will be **[CBSE AIPMT 1991, 1992]**

- (a) dependent on intensity of refracted light
 (b) same
 (c) smaller
 (d) larger

Ans. (c)

Refractive index,

$$\mu = \frac{c}{v} = \frac{v\lambda_v}{v\lambda_m}$$

As,

c = velocity of light in vacuum
 v = velocity of light in medium

$v = v\lambda$ and v remains constant during refraction

$$\therefore \lambda_m = \frac{\lambda_v}{\mu}$$

$$\Rightarrow \lambda_m < \lambda_v \quad (\because \mu > 1, \text{ given})$$

Hence, the wavelength decreases in second medium.

- 45** A ray is incident at an angle of incidence i on one surface of a prism of small angle A and emerge normally from opposite surface. If the refractive index of the material of prism is μ , the angle of incidence i is nearly equal to **[CBSE AIPMT 1989]**

- (a) $\frac{A}{\mu}$ (b) $\frac{A}{2\mu}$ (c) μA (d) $\frac{\mu A}{2}$

Ans. (c)

Angle of prism is given by $A = r_1 + r_2$ where, r_1 is refraction angle on incident face and r_2 is angle of incidence on 2nd face of prism. As refracted ray emerges normally from opposite surface, $r_2 = 0$.

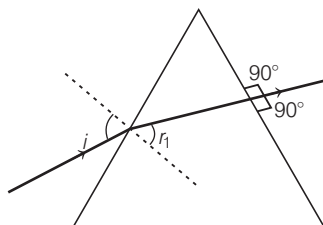

$$\therefore A = r_1$$

$$\text{Now, } \mu = \frac{\sin i}{\sin r_1}$$

If $\angle i_1$ and $\angle r_1$ are very small then, $\sin i \approx i$, $\sin r_1 \approx r_1$

$$\therefore \mu = \frac{i}{r_1} = \frac{i}{A}$$

$$\therefore i = \mu A$$

TOPIC 3 Lenses

- 46.** A convex lens A of focal length 20 cm and a concave lens B of focal length 5 cm are kept along the same axis with a distance d between them. If a parallel beam of light falling on A leaves B as a parallel beam, then the distance d (in cm) will be **[NEET 2021]**
- (a) 25 (b) 15 (c) 50 (d) 30

Ans. (b)

Given, the focal length of convex lens A,

$$f_1 = +20 \text{ cm}$$

The focal length of concave lens B,

$$f_2 = -5 \text{ cm}$$

The convex lens is the converging lens and the concave lens is the diverging lens.

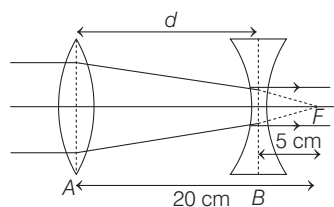

When the parallel beam of light passes through the convex lens, it converges at the focal point F and the distance between lens A to F point is 20 cm.

Now, after emerging from the lens B, the beam is still parallel in nature. So, the net focal length of the lens A and B will be infinite.

As we know,

$$\frac{1}{f} = \frac{1}{f_1} + \frac{1}{f_2}$$

$$\Rightarrow \frac{1}{\infty} = \frac{1}{20} - \frac{1}{5} + \frac{d}{20 \times 5}$$

$$\Rightarrow \frac{3}{20} = \frac{d}{20 \times 5} \quad \text{or } d = 3 \times 5 = 15 \text{ cm}$$

- 47** A point object is placed at a distance of 60 cm from a convex lens of focal length 30 cm. If a plane mirror were put perpendicular to the principal axis of the lens and at a distance of 40 cm from it, the final image would be formed at a distance of **[NEET 2021]**

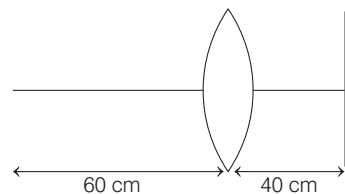

- (a) 20 cm from the lens, it would be a real image
 (b) 30 cm from the lens, it would be a real image
 (c) 30 cm from the plane mirror, it would be a virtual image
 (d) 20 cm from the plane mirror, it would be a virtual image

Ans. (d)

Given, the focal length of the convex lens,

$$f = +30 \text{ cm}$$

The object distance from the lens,
 $u = -60 \text{ cm}$

The image formed by the lens be at distance v , then by using lens formula,

$$\frac{1}{f} = \frac{1}{v} - \frac{1}{u}$$

$$\frac{1}{+30} = \frac{1}{v} - \frac{1}{(-60)} \Rightarrow \frac{1}{+30} = \frac{60+v}{60v}$$

$$\Rightarrow 2v = 60 + v \Rightarrow v = 60 \text{ cm}$$

Let's draw the ray diagram of the convex lens and mirror.

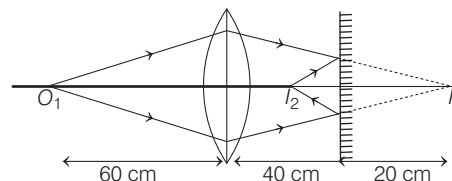

This real image will now act as a virtual object for the mirror.
Thus, a real image from the mirror is formed 20 cm in front of the mirror.
Hence, at 20 cm distance from the lens. Also, this real image acts as an object for lens for final image.

Again by using lens formula,

$$\frac{1}{v} + \frac{1}{20} = \frac{1}{30}$$

or $v = -60$ cm from the lens
i.e., 20 cm from the plane mirror and virtual in nature.

48 A plano-convex lens of unknown material and unknown focal length is given. With the help of a spherometer we can measure the [NEET (Oct.) 2020]

- (a) focal length of the lens
(b) radius of curvature of the curved surface
(c) aperture of the lens
(d) refractive index of the material

Ans. (b)

Spherometer is used to measure the radius of curvature of an item such as a lens and curved mirrors that are spherical in shape.

49 The power of a biconvex lens is 10 D and the radius of curvature of each surface is 10 cm. Then, the refractive index of the material of the lens is [NEET (Oct.) 2020]

- (a) $\frac{4}{3}$ (b) $\frac{9}{8}$ (c) $\frac{5}{3}$ (d) $\frac{3}{2}$

Ans. (d)

Power of biconvex lens,

$$P = 10\text{D}$$

$$\therefore f = \frac{1}{P} = \frac{1}{10} = 0.1\text{m} = 10\text{cm}$$

$$R_1 = R_2 = 10\text{cm}$$

By lens Maker's formula,

$$\frac{1}{f} = (\mu - 1) \left(\frac{1}{R_1} - \frac{1}{R_2} \right)$$

$$\Rightarrow \frac{1}{10} = (\mu - 1) \left(\frac{1}{10} - \frac{1}{-10} \right)$$

$$\Rightarrow \frac{1}{10} = (\mu - 1) \left(\frac{2}{10} \right)$$

$$\Rightarrow 1 = (\mu - 1) \times 2$$

$$\Rightarrow \mu - 1 = \frac{1}{2}$$

$$\Rightarrow \mu = 1 + \frac{1}{2} = \frac{3}{2}$$

50 An equi-convex lens has power P it is cut into two symmetrical halves by a plane containing the principal axis. The power of one part will be [NEET (Odisha) 2019]

- (a) 0 (b) $\frac{P}{2}$ (c) $\frac{P}{4}$ (d) P

Ans. (d)

When the lens is cut along its principal axis, the focal length of the two halves will remain same because the radius of curvature of both the surfaces are still same. So, the power also remains same as

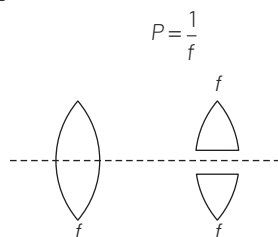

51 A double convex lens has focal length 25 cm. The radius of curvature of one of the surfaces is doubled of the other. Find the radii, if the refractive index of the material of the lens is 1.5. [NEET (Odisha) 2019]

- (a) 100 cm, 50 cm
(b) 25 cm, 50 cm
(c) 18.75 cm, 37.5 cm
(d) 50 cm, 100 cm

Ans. (c)

Using the lens maker's formula

$$\frac{1}{f} = \left(\frac{\mu_2 - \mu_1}{\mu_1} \right) \left(\frac{1}{R_1} - \frac{1}{R_2} \right)$$

Here, $f = 25\text{cm}$, $\mu_2 = 1.5$, $\mu_1 = 1$ (for air)

let $R_1 = R$ and $R_2 = -2R$

$$\Rightarrow \frac{1}{25} = \left(\frac{1.5 - 1}{1} \right) \left[\frac{1}{R} - \left(-\frac{1}{2R} \right) \right]$$

$$\frac{1}{25 \times 0.5} = \frac{1}{R} + \frac{1}{2R}$$

$$\Rightarrow R = \frac{3}{2} \times 25 \times 0.5 = 18.75\text{cm}$$

$$\therefore R_1 = 18.75\text{cm}$$

$$R_2 = 2 \times 18.75 = 37.5\text{cm}$$

52 Two similar thin equi-convex lenses, of focal length f each, are kept co-axially in contact with each other such that the focal length of the combination is F_1 .

When the space between the two lenses is filled with glycerine (which has the same refractive index ($\mu = 1.5$) as that of glass) then the equivalent focal length is F_2 .

The ratio $F_1 : F_2$ will be

[NEET (National) 2019]

- (a) 1 : 2 (b) 2 : 3
(c) 3 : 4 (d) 2 : 1

Ans. (a)

Key Idea When the space between two convex lenses is filled with a liquid of refractive index same as that of glass of lens, then it behaves like a diverging lens, i.e. it forms a bi-concave lens.

Case I When two equi-convex lens of focal length f_1 and f_2 respectively, are kept co-axially in contact, then the equivalent focal length of combination is

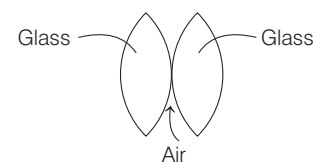

$$\frac{1}{F_1} = \frac{1}{f_1} + \frac{1}{f_2} = \frac{1}{f} + \frac{1}{f} \quad [\because \text{Here, } f_1 = f_2]$$

$$= \frac{2}{f}$$

$$\Rightarrow F_1 = \frac{f}{2} \quad \dots (i)$$

Case II When glycerine of same refractive index at that of the glass is filled in the space between two lens, then the combination will now comprises of three lenses; first bi-convex, second bi-concave and third is bi-convex. So, the focal length of the combination now is given as

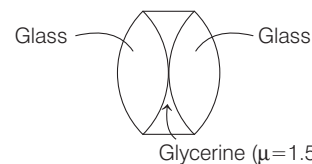

$$\frac{1}{F_2} = \frac{1}{f} + \frac{1}{(-f)} + \frac{1}{f} = \frac{1}{f}$$

$$\Rightarrow F_2 = f \quad \dots (ii)$$

From Eqs. (i) and (ii), we get

$$F_1 : F_2 = 1 : 2$$

53 Two identical glass ($\mu_g = 3/2$) equi-convex lenses of focal length f each are kept in contact. The space between the two lenses is

filled with water ($\mu_w = 4/3$). The focal length of the combination is [NEET 2016]

- (a) $f/3$ (b) f
 (c) $\frac{4f}{3}$ (d) $\frac{3f}{4}$

Ans. (d)

Consider the situation shown in figure. Let radius of curvature of lens surfaces is R . The combination is equivalent to three lenses in contact.

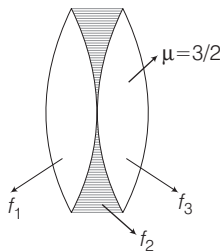

$$\therefore \frac{1}{f_{eq}} = \frac{1}{f_1} + \frac{1}{f_2} + \frac{1}{f_3}$$

$$= \frac{2}{f_1} + \frac{1}{f_2} \quad (\because f_1 = f_3)$$

$$\text{Now } \frac{1}{f_1} = \frac{1}{f_3} = (\mu - 1) \left(\frac{2}{R} \right) = \frac{1}{f}$$

$$\frac{1}{f_2} = (\mu_w - 1) \left(-\frac{2}{R} \right) = \left(\frac{4}{3} - 1 \right) \left(-\frac{2}{R} \right)$$

$$= \left(\frac{1}{3} \right) \left(-\frac{2}{R} \right) = \left(-\frac{2}{3} \right) \left(\frac{1}{2(\mu - 1)} \right)$$

$$\Rightarrow \frac{1}{f_2} = \left(-\frac{1}{3} \right) \left(\frac{1}{\frac{3}{2} - 1} \right) \left(\frac{1}{f} \right) = -\frac{2}{3} \times \frac{1}{f}$$

$$\therefore \frac{1}{f_{eq}} = \frac{2}{f} - \frac{2}{3} \times \frac{1}{f}$$

$$= \frac{6 - 2}{3f} = \frac{4}{3f}$$

$$\Rightarrow f_{eq} = \frac{3f}{4}$$

54 Two identical thin plano-convex glass lenses (refractive index 1.5) each having radius of curvature of 20 cm are placed with their convex surfaces in contact at the centre. The intervening space is filled with oil of refractive index 1.7. The focal length of the combination is [CBSE AIPMT 2015]

- (a) -20 cm
 (b) -25 cm
 (c) -50 cm
 (d) 50 cm

Ans. (c)

Given $\mu_g = 1.5$

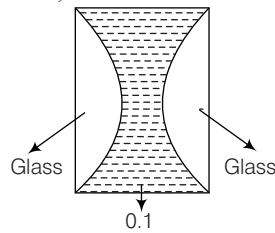

$$\mu_{oil} = 1.7 \Rightarrow R = 20 \text{ cm}$$

From Lens Maker's formula for the plano convex lens

$$\frac{1}{f} = (\mu - 1) \left[\frac{1}{R_1} - \frac{1}{R_2} \right]$$

Here, $R_1 = R$
 and for plane surface $R_2 = \infty$

$$\therefore \frac{1}{f_{lens}} = (1.5 - 1) \left(\frac{1}{R} - 0 \right) \Rightarrow \frac{1}{f_{lens}} = \frac{0.5}{R}$$

When the intervening medium is filled with oil, then focal length of the concave lens formed by the oil

$$\frac{1}{f_{concave}} = (1.7 - 1) \left(-\frac{1}{R} - \frac{1}{R} \right)$$

$$= -0.7 \times \frac{2}{R} = \frac{-1.4}{R}$$

Here, we have two concave surfaces

$$\text{So, } \frac{1}{f_{eq}} = 2 \times \frac{1}{f} + \frac{1}{f}$$

$$= 2 \times \frac{0.5}{R} + \left(\frac{-1.4}{R} \right) = \frac{1}{R} - \frac{1.4}{R} = -\frac{0.4}{R}$$

$$\therefore f_{eq} = -\frac{R}{0.4} = -\frac{20}{0.4} = -50 \text{ cm}$$

55 A plano-convex lens fits exactly into a plano-concave lens. Their plane surfaces are parallel to each other. If lenses are made of different materials of refractive indices μ_1 and μ_2 and R is the radius of curvature of the curved surface of the lenses, then the focal length of the combination is [NEET 2013]

- (a) $\frac{R}{2(\mu_1 + \mu_2)}$ (b) $\frac{R}{2(\mu_1 - \mu_2)}$
 (c) $\frac{R}{(\mu_1 - \mu_2)}$ (d) $\frac{2R}{(\mu_2 - \mu_1)}$

Ans. (c)

Focal length of the combination

$$\frac{1}{f} = \frac{1}{f_1} + \frac{1}{f_2} \quad \dots(i)$$

$$\text{We have } \frac{1}{f_1} = (\mu_1 - 1) \left(\frac{1}{\infty} - \frac{1}{-R} \right) = \frac{\mu_1 - 1}{R}$$

$$\text{and } \frac{1}{f_2} = (\mu_2 - 1) \left(\frac{1}{-R} - \frac{1}{\infty} \right) = -\frac{(\mu_2 - 1)}{R}$$

Putting these values of $\frac{1}{f_1}$ and $\frac{1}{f_2}$ in Eq. (i)

$$\frac{1}{f} = \frac{(\mu_1 - 1)}{R} - \frac{(\mu_2 - 1)}{R}$$

$$= \frac{[\mu_1 - 1 - \mu_2 + 1]}{R} = \frac{\mu_1 - \mu_2}{R}$$

$$f = \frac{R}{\mu_1 - \mu_2}$$

56 When a biconvex lens of glass having refractive index 1.47 is dipped in a liquid, it acts as a plane sheet of glass. This implies that the liquid must have refractive index [CBSE AIPMT 2012]

- (a) equal to that of glass
 (b) less than one
 (c) greater than that of glass
 (d) less than that of glass

Ans. (a)

If biconvex lens behaves like a plane sheet of glass, ray will pass undeviated through it only when medium has same refractive index as that of biconvex lens.

57. A biconvex lens has a radius of curvature of magnitude 20 cm. Which one of the following options describe best the image formed of an object of height 2 cm placed 30 cm from the lens? [CBSE AIPMT 2011]

- (a) Virtual, upright, height = 0.5 cm
 (b) Real, inverted, height = 4 cm
 (c) Real, inverted, height = 1 cm
 (d) Virtual, upright, height = 1 cm

Ans. (b)

Given, $R = 20$ cm

$$h_o = 2 \text{ cm and } u = -30 \text{ cm}$$

In general we have assumed $\mu = 1.5$

$$\text{As } \frac{1}{f} = (1.5 - 1) \times \frac{2}{20} = \frac{1}{20}$$

So, $f = 20$ cm

$$\text{Now, as } \frac{1}{f} = \frac{1}{v} + \frac{1}{u}$$

$$\frac{1}{20} = \frac{1}{v} + \frac{1}{30}$$

$$\frac{1}{v} = \frac{1}{20} - \frac{1}{30} = \frac{10}{600}$$

$\therefore v = 60$ cm

$$\text{As } m = \frac{v}{u} = \frac{60}{-30} = -2$$

$$\Rightarrow m = \frac{h_i}{h_o} = -2$$

$$\therefore h_i = -2 \times 2 = -4 \text{ cm}$$

Here, image is real, inverted, magnified and height of image is 4 cm.

- 58** A lens having focal length f and aperture of diameter d forms an image of intensity I . Aperture of diameter $\frac{d}{2}$ in central region of

lens is covered by a black paper. Focal length of lens and intensity of image now will be respectively

[CBSE AIPMT 2010]

- (a) f and $\frac{I}{4}$ (b) $\frac{3f}{4}$ and $\frac{I}{2}$
 (c) f and $\frac{3I}{4}$ (d) $\frac{f}{2}$ and $\frac{I}{2}$

Ans. (c)

As we know that
 Intensity, $I \propto A$ (Area exposed)

$$\Rightarrow \frac{I_2}{I_1} = \left[\frac{A_2}{A_1} \right]$$

$$= \frac{\frac{\pi d^2}{4} - \frac{\pi d^2/4}{4}}{\frac{\pi d^2}{4}} = \frac{3}{4}$$

$$\Rightarrow I_2 = \frac{3}{4} I_1$$

and focal length remains unchanged.

- 59** A boy is trying to start a fire by focusing sunlight on a piece of paper using an equiconvex lens of focal length 10 cm. The diameter of the sun is 1.39×10^9 m and its mean distance from the earth is 1.5×10^{11} m. What is the diameter of the sun's image on the paper? [CBSE AIPMT 2008]

- (a) 9.2×10^{-4} m (b) 6.5×10^{-4} m
 (c) 6.5×10^{-5} m (d) 12.4×10^{-4} m

Ans. (a)

The diameter of the sun, $O = 1.39 \times 10^9$ m and its image is I . As the distance of sun from lens $u = 1.5 \times 10^{11}$ m and from paper is $v = 0.1$ m.

Then by using relation

$$\frac{I}{O} = \frac{v}{u}$$

$$\Rightarrow \frac{I}{1.39 \times 10^9} = \frac{0.1}{1.5 \times 10^{11}}$$

we get $I = 9.2 \times 10^{-4}$ m

- 60** Two thin lenses of focal lengths f_1 and f_2 are in contact and coaxial. The power of the combination is

[CBSE AIPMT 2008]

- (a) $\sqrt{\frac{f_1}{f_2}}$ (b) $\sqrt{\frac{f_2}{f_1}}$
 (c) $\frac{f_1 + f_2}{2}$ (d) $\frac{f_1 f_2}{f_1 + f_2}$

Ans. (d)

As and we know that $P_{\text{eq}} = P_1 + P_2$

$$\frac{1}{F_{\text{eq}}} = \frac{1}{f_1} + \frac{1}{f_2}$$

$$\therefore F_{\text{eq}} = \frac{f_1 f_2}{f_1 + f_2}$$

As $P = \frac{1}{F}$

$$\therefore P_{\text{eq}} = \frac{f_1 + f_2}{f_1 f_2}$$

- 61** A convex lens and a concave lens, each having same focal length of 25 cm, are put in contact to form a combination of lenses. The power in diopters of the combination is

[CBSE AIPMT 2006]

- (a) 25 (b) 50
 (c) infinite (d) zero

Ans. (d)

Focal length of combination of lenses placed in contact is

$$\frac{1}{F} = \frac{1}{f_1} + \frac{1}{f_2}$$

For convex lens $f_1 = 25$ cm

For concave lens, $f_2 = -25$ cm

$$\text{Hence, } \frac{1}{F} = \frac{1}{25} + \frac{1}{-25} = \frac{1}{25} - \frac{1}{25} = 0$$

$$\therefore F = \frac{1}{0} = \infty$$

Hence, power of combination,

$$P = \frac{1}{F} = 0 \text{ D}$$

- 62** A convex lens is dipped in a liquid whose refractive index is equal to the refractive index of the lens. Then its focal length will

[CBSE AIPMT 2003]

- (a) become small, but non-zero
 (b) remain unchanged
 (c) become zero
 (d) become infinite

Ans. (d)

From lens maker's formula

$$\frac{1}{f} = (\mu_g - 1) \left(\frac{1}{R_1} - \frac{1}{R_2} \right) \quad \dots(i)$$

When convex lens is dipped in a liquid of refractive index (μ_l), then its focal length becomes

$$\frac{1}{f_l} = \left(\frac{\mu_g}{\mu_l} - 1 \right) \left(\frac{1}{R_1} - \frac{1}{R_2} \right)$$

$$\text{or } \frac{1}{f_l} = \frac{(\mu_g - \mu_l)}{\mu_l} \left(\frac{1}{R_1} - \frac{1}{R_2} \right) \quad \dots(ii)$$

Dividing Eq. (i) by Eq. (ii), we get

$$\frac{f_l}{f} = \frac{(\mu_g - 1)\mu_l}{(\mu_g - \mu_l)} \quad \dots(iii)$$

But it is given that refractive index of lens is equal to refractive index of liquid i.e. $\mu_g = \mu_l$.

Hence, Eq. (iii) gives,

$$\frac{f_l}{f} = \frac{(\mu_g - 1)\mu_l}{0} = \infty \quad (\text{infinity})$$

- 63** An equiconvex lens is cut into two halves along (i) XOX' and (ii) YOY' as shown in the figure. Let f, f', f'' be the focal lengths of the complete lens, of each half in case (i), and of each half in case (ii), respectively.

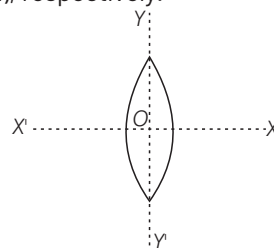

Choose the correct statement from the following

[CBSE AIPMT 2003]

- (a) $f' = f, f'' = f$ (b) $f' = 2f, f'' = 2f$
 (c) $f' = f, f'' = 2f$ (d) $f' = 2f, f'' = f$

Ans. (c)

Initially, the focal length of equiconvex lens is

$$\frac{1}{f} = (\mu - 1) \left(\frac{1}{R_1} - \frac{1}{R_2} \right) \quad \dots(i)$$

$$\frac{1}{f} = (\mu - 1) \left(\frac{1}{R} - \frac{1}{-R} \right) = \frac{2(\mu - 1)}{R}$$

Case I When lens is cut along XOX' , then each half is again equiconvex with

$$R_1 = R, R_2 = -R$$

$$\text{Thus, } \frac{1}{f'} = (\mu - 1) \left[\frac{1}{R} - \frac{1}{(-R)} \right]$$

$$= (\mu - 1) \left[\frac{1}{R} + \frac{1}{R} \right]$$

$$= (\mu - 1) \frac{2}{R} = \frac{1}{f'}$$

$$\Rightarrow f' = f$$

Case II When lens is cut along YOY', then each half becomes planoconvex with

$$\begin{aligned} R_1 &= R, R_2 = \infty \\ \text{Thus, } \frac{1}{f''} &= (\mu - 1) \left(\frac{1}{R_1} - \frac{1}{R_2} \right) \\ &= (\mu - 1) \left(\frac{1}{R} - \frac{1}{\infty} \right) \\ &= \frac{(\mu - 1)}{R} = \frac{1}{2f} \end{aligned}$$

Hence, $f' = f, f'' = 2f$

Note When we cut a convex lens along principal axis both the lens formed are convex lens of same focal length as that of original.

When we cut a convex lens vertical to principal axis, each lens has focal length twice of original.

- 64** A body is located on a wall. Its image of equal size is to be obtained on a parallel wall with the help of a convex lens. The lens is placed at a distance d ahead of second wall, then the required focal length will be [CBSE AIPMT 2002]

- (a) only $\frac{d}{4}$
 (b) only $\frac{d}{2}$
 (c) more than $\frac{d}{4}$ but less than $\frac{d}{2}$
 (d) less than $\frac{d}{4}$

Ans. (b)

Concept For equal size of image and object, object must be placed of centre of curvature of lens i.e. $u = v$.

The lens formula can be written as

$$\frac{1}{f} = \frac{1}{v} - \frac{1}{u} \quad \dots(i)$$

Given, $v = d$

For equal sized image,

$$|v| = |u| = d$$

By sign convention,

$$\therefore \frac{1}{f} = \frac{1}{d} + \frac{1}{d} \text{ or } f = \frac{d}{2}$$

- 65** A planoconvex lens is made of a material of refractive index $\mu = 1.5$. The radius of curvature of curved surface of the lens is 20 cm. If its

plane surface is silvered, the focal length of the silvered lens will be

[CBSE AIPMT 2000]

- (a) 10 cm (b) 20 cm
 (c) 40 cm (d) 80 cm

Ans. (b)

When a ray falls on convex surface of a planoconvex lens, then it is first refracted and reflected from plane surface and then finally refracted from convex surface. Thus, two refractions and one reflection take place.

Since, refraction takes place two times and reflection takes place one time

So, focal length of planoconvex lens is

$$\frac{1}{F} = \frac{2}{f_i} + \frac{1}{f_m} \quad \dots(i)$$

If plane surface is silvered, so

$$f_m = \frac{R_2}{2} = \frac{\infty}{2} = \infty$$

And from lens maker formula

$$\begin{aligned} \frac{1}{f_i} &= (\mu - 1) \left(\frac{1}{R_1} - \frac{1}{R_2} \right) \\ &= (\mu - 1) \left(\frac{1}{R} - \frac{1}{\infty} \right) = \frac{(\mu - 1)}{R} \end{aligned}$$

$$\therefore \frac{1}{F} = \frac{2(\mu - 1)}{R} + \frac{1}{\infty} = \frac{2(\mu - 1)}{R}$$

$$\text{or } F = \frac{R}{2(\mu - 1)} \quad \dots(ii)$$

Given, $R = 20 \text{ cm}, \mu = 1.5$
 Hence, $F = \frac{20}{2(1.5 - 1)} = \frac{20}{2 \times 0.5} = 20 \text{ cm}$

- 66** A planoconvex lens is made of material of refractive index 1.6. The radius of curvature of the curved surface is 60 cm. The focal length of the lens is

[CBSE AIPMT 1999]

- (a) 50 cm (b) 100 cm
 (c) 200 cm (d) 400 cm

Ans. (b)

According to Lens maker's formula, focal length of lens is given by

$$\frac{1}{f} = (\mu - 1) \left(\frac{1}{R_1} - \frac{1}{R_2} \right) \quad \dots(i)$$

We know that for planoconvex lens, the radius of curvature of plane surface is infinite,

i.e. $R_2 = \infty$.

Given, $R_1 = 60 \text{ cm}, \mu = 1.6$

Substituting the given values in Eq. (i), we get

$$\frac{1}{f} = (1.6 - 1) \left(\frac{1}{60} - \frac{1}{\infty} \right) = 0.6 \times \frac{1}{60}$$

\therefore Focal length of plane convex lens

$$f = \frac{60}{0.6} = 100 \text{ cm}$$

- 67** A luminous object is placed at a distance of 30 cm from the convex lens of focal length 20 cm. On the other side of the lens, at what distance from the lens, a convex mirror of radius of curvature 10 cm, be placed in order to have an upright image of the object coincident with it? [CBSE AIPMT 1998]

- (a) 12 cm (b) 30 cm
 (c) 50 cm (d) 60 cm

Ans. (c)

The ray diagram for the problem is shown as follows

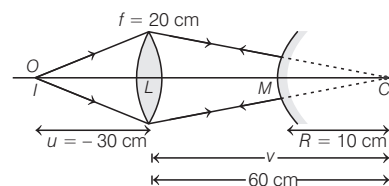

According to lens formula, $\frac{1}{f} = \frac{1}{v} - \frac{1}{u}$

We have $u = -30 \text{ cm}, f = 20 \text{ cm}$

$$\therefore \frac{1}{20} = \frac{1}{v} - \frac{1}{-30}$$

$$\text{or } \frac{1}{v} = \frac{1}{20} - \frac{1}{30} = \frac{3-2}{60} = \frac{1}{60}$$

$\therefore v = 60 \text{ cm}$

For the image (I) coincident with object (O), the rays after refraction from the lens must fall on the convex mirror normally or the rays refracted from lens must meet at C.

$\therefore LC = v = 60 \text{ cm}$

Thus, distance between lens and mirror

$$LM = 60 - 10 = 50 \text{ cm}$$

- 68** The focal lengths of a converging lens measured for violet, green and red colours are f_V, f_G, f_R respectively. We will find

[CBSE AIPMT 1997]

- (a) $f_G > f_R$ (b) $f_V < f_R$
 (c) $f_V > f_R$ (d) $f_V = f_R$

Ans. (b)

Lens maker's formula is

$$\frac{1}{f} = (\mu - 1) \left(\frac{1}{R_1} - \frac{1}{R_2} \right)$$

or $\frac{1}{f} \propto \mu$ or $f \propto \frac{1}{\mu}$... (i)

According to Cauchy's formula,

$\mu \propto \frac{1}{\lambda}$... (ii)

From Eqs. (i) and (ii), we get $f \propto \lambda$

Hence, focal length of a converging lens is maximum for red colour (highest wavelength) and minimum for violet colour (lowest wavelength)

i.e. $f_v < f_r$

69 A convex lens of focal length 80 cm and a concave lens of focal length 50 cm are combined together. What will be their resulting power?

[CBSE AIPMT 1996]

- (a) +6.5 D (b) -6.5 D
(c) +7.5 D (d) -0.75 D

Ans. (d)

Power of a lens is the ability of the lens to converge a beam of light falling on the lens. It is measured as the reciprocal of focal length of the lens.

i.e. $P = \frac{1}{f_{(imm)}}$

When f is in cm,

$P = \frac{100}{f}$ D

Here, $f_1 = 80$ cm, $f_2 = -50$ cm

Combined power of two lenses in contact is given by $P_{eq} = P_1 + P_2$

$\Rightarrow P_{eq} = \frac{1}{f_1(m)} + \frac{1}{f_2(m)}$

[f_1 and f_2 are with sign]

$\therefore P = \frac{100}{80} - \frac{100}{50} = -0.75$ D

70 A lens is placed between a source of light and a wall. It forms images of area A_1 and A_2 on the wall, for its two different positions, the area of the source of light is

[CBSE AIPMT 1995]

- (a) $\sqrt{A_1 A_2}$ (b) $\frac{A_1 + A_2}{2}$
(c) $\frac{A_1 - A_2}{2}$ (d) $\frac{1}{A_1} + \frac{1}{A_2}$

Ans. (a)

In displacement method, total magnification $m = \sqrt{m_1 m_2}$. Therefore, area of source is given by $A = \sqrt{A_1 A_2}$.

71 Focal length of a convex lens will be maximum for

[CBSE AIPMT 1994]

- (a) blue light (b) yellow light
(c) green light (d) red light

Ans. (d)

As wavelength of violet light $\lambda_{violet} <$ Wave length of red light λ_{red} , therefore, refractive index of violet light $\mu_{violet} >$ Refractive index of red light μ_{red} . Hence, $f_{red} > f_{violet}$

So, focal length of lens for red light is maximum than other visible spectrum of light.

72 Focal length of a convex lens of refractive index 1.5 is 2 cm. Focal length of lens when immersed in a liquid of refractive index 1.25 will be

[CBSE AIPMT 1988]

- (a) 10 cm (b) 2.5 cm
(c) 5 cm (d) 7.5 cm

Ans. (c)

Focal length of convex lens in air is given by

$\frac{1}{f_o} = (\mu_g - 1) \left(\frac{1}{R_1} - \frac{1}{R_2} \right)$... (i)

Focal length of convex lens when immersed in liquid of refractive index μ_l is given by

$\frac{1}{f_i} = (\mu_g - \mu_l) \left(\frac{1}{R_1} - \frac{1}{R_2} \right)$

μ_g = refractive index of glass w.r.t. liquid

R_1, R_2 = radius of curvature of lens spherical surface

or $\frac{1}{f_i} = \left(\frac{\mu_g - \mu_l}{\mu_l} \right) \left(\frac{1}{R_1} - \frac{1}{R_2} \right)$... (ii)

From Eqs. (i) and (ii),

$\frac{1}{f_o} = \frac{(\mu_g - 1)}{(\mu_l - 1)}$ or $\frac{f_i}{f_o} = \frac{(\mu_g - 1)}{(\mu_l - 1)}$

or $\frac{f_i}{f_o} = \frac{(1.5 - 1)}{(1.25 - 1)} = \frac{1/2}{1/5} = \frac{5}{2}$

$\therefore f_i = \frac{5}{2} f_o = \frac{5}{2} \times 2 = 5$ cm

TOPIC 4

Optical Instruments

73 A lens of large focal length and large aperture is best suited as an objective of an astronomical telescope, since

[NEET 2021]

- (a) a large aperture contributes to the quality and visibility of the images
(b) a large area of the objective ensures better light gathering power
(c) a large aperture provides a better resolution
(d) All of the above

Ans. (d)

The objective of an astronomical telescope has large focal length and large aperture. Because the lens used is convex lens and the magnification of an astronomical telescope is directly proportional to the focal length of the objective lens.

This large aperture also contributes to the better quality and visibility of the images. Thus, it provides better resolution.

Due to large focal length of the objective, it covers large area which ensures better light gathering power.

Thus, all options (a), (b) and (c) are correct.

74 A astronomical telescope has objective and eyepiece of focal lengths 40 cm 4 cm respectively. To view an object 200 cm away from the objective, the lenses must be separated by a distance

[NEET 2016]

- (a) 46.0 cm (b) 50.0 cm
(c) 54.0 cm (d) 37.3 cm

Ans. (c)

According to question,

Focal length of objective lens (F_o) = +40 cm

Focal length of eyepiece lens (F_e) = 4 cm

Object distance for objective lens

(u_o) = -200 cm

Applying lens formula for objective lens

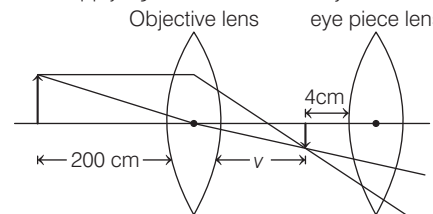

$\frac{1}{v} - \frac{1}{u} = \frac{1}{f} \Rightarrow \frac{1}{v} - \frac{1}{-200} = \frac{1}{40}$

$\Rightarrow \frac{1}{v} = \frac{1}{40} - \frac{1}{200} = \frac{5-1}{200} = \frac{4}{200}$

$\Rightarrow v = 50$ cm

Image will be form at first focus of eyepiece lens.

So, for normal adjustment distance between objectives and eye piece lens (length of tube) will be

$$v + F_e \Rightarrow 50 + 4 \Rightarrow 54 \text{ cm}$$

74 A person can see clearly objects only when they lie between 50 cm and 400 cm from his eyes. In order to increase the maximum distance of distinct vision to infinity, the type and power of the correcting lens, the person has to use, will be [NEET 2016]

- (a) convex, + 2.25 diopter
 (b) concave, - 0.25 diopter
 (c) concave - 0.2 diopter
 (d) convex, + 0.15 diopter

Ans. (b)

Key Idea Image of object at ∞ must lie within distance upto which person can view clearly.

Image distance, $v = 400 \text{ cm} = 4 \text{ m} \Rightarrow u = \infty$

Using lens equation,

$$\frac{1}{v} - \frac{1}{u} = \frac{1}{f}$$

$$\Rightarrow \frac{1}{-4} - \frac{1}{\infty} = \frac{1}{f}$$

$$\Rightarrow f = -4 \text{ m}$$

Now power of the required lens is,

$$P = \frac{1}{f} = \frac{1}{-4} = -0.25 \text{ D}$$

Thus, the person require a concave lens of power - 0.25 D.

76 In an astronomical telescope in normal adjustment a straight black line of length L is drawn on inside part of objective lens. The eye-piece forms a real image of this line. The length of this image is l . The magnification of the telescope is [CBSE AIPMT 2015]

- (a) $\frac{L}{l} + 1$ (b) $\frac{L}{l} - 1$ (c) $\frac{L+1}{L-1}$ (d) $\frac{L}{l}$

Ans.(d)

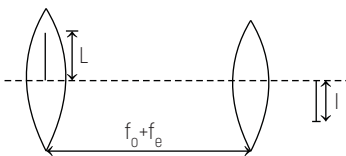

We know, magnification of telescope, we have

$$M = \frac{f_o}{f_e}$$

Here $\frac{f_e}{f_e + u} = \frac{-l}{L}$

$$\Rightarrow \frac{f_e}{f_e - (f_o + f_e)} = \frac{-l}{L}$$

$$\Rightarrow \frac{f_e}{f_o} = \frac{l}{L}$$

i.e. $M = \frac{L}{l}$

77 If the focal length of objective lens is increased, then magnifying power of [CBSE AIPMT 2014]

- (a) microscope will increase but that of telescope decrease
 (b) microscope and telescope both will increase
 (c) microscope and telescope both will decrease
 (d) microscope will decrease but that of telescope will increase

Ans. (d)

For microscope, $m = \frac{L D}{f_o f_e} \Rightarrow m \propto \frac{1}{f_o}$

For telescope, $m = \frac{f_o}{f_e}$
 $m \propto f_o$

The magnifying power of microscope will decrease but the magnifying power of telescope will increase.

78 For a normal eye, the cornea of eye provides a converging power of 40 D and the least converging power of the eye lens behind the cornea is 20 D. Using this information, the distance between the retina and the cornea, eye lens can be estimated to be [NEET 2013]

- (a) 5 cm (b) 2.5 cm
 (c) 1.67 cm (d) 1.5 cm

Ans.(c)

Given, power (P_1) = 40 D and power (P_2) = 20 D

We have $P_{eq} = P_1 + P_2$
 $= 40 + 20 = 60 \text{ D}$

So, $\frac{1}{f_{eq}} = \frac{1}{f_1} + \frac{1}{f_2}$

$$\Rightarrow f_{eq} = \frac{100}{P_{eq}} = \frac{100}{60} = 1.67 \text{ cm}$$

79 The magnifying power of a telescope is 9. When it is adjusted for parallel rays the distance between the objective and

eyepiece is 20 cm. The focal length of lenses are [CBSE AIPMT 2012]

- (a) 10 cm, 10 cm (b) 15 cm, 5 cm
 (c) 18 cm, 2 cm (d) 11 cm, 9 cm

Ans. (c)

Given, Magnification = $\frac{f_o}{f_e} = 9$

and $f_o + f_e = 20$

$$f_o = 9f_e$$

So, $9f_e + f_e = 20$

$$f_e = 2 \text{ cm}$$

$\therefore f_o = 9 \times 2$

$$f_o = 18 \text{ cm}$$

80 A microscope is focussed on a mark on a piece of paper and then a slab of glass of thickness 3 cm and refractive index 1.5 is placed over the mark. How should the microscope be moved to get the mark in focus again?

[CBSE AIPMT 2006]

- (a) 1 cm upward
 (b) 4.5 cm downward
 (c) 1 cm downward
 (d) 2 cm upward

Ans. (a)

Apparent depth of mark as seen through a glass slab of thickness x and refractive index μ is

$$\text{Apparent depth} = \frac{\text{real depth}}{\text{refractive index}}$$

or $x' = \frac{x}{\mu} = \frac{3}{1.5} = 2 \text{ cm}$

As image appears to be raised by 1 cm, therefore, microscope must be moved upward by 1 cm.

81 A telescope has an objective lens of 10 cm diameter and is situated at a distance of one kilometre from two objects. The minimum distance between these two objects, which can be resolved by the telescope, when the mean wavelength of light is 5000 \AA , is of the order of [CBSE AIPMT 2004]

- (a) 0.5 m (b) 5 m
 (c) 5 mm (d) 5 cm

Ans. (c)

Resolving limit of telescope is given by

$$\theta \propto \frac{\lambda}{D} = \frac{\lambda}{d}$$

λ = wavelength
 d = diameter of objective lens of telescope
 D = Distance between object and telescope

$$\Rightarrow x = \frac{\lambda D}{d}$$

Given, $\lambda = 5000 \text{ \AA} = 5000 \times 10^{-10} \text{ m}$,
 $D = 1 \text{ km} = 1000 \text{ m}$,
 $d = 10 \text{ cm} = 0.1 \text{ m}$

$$\text{Hence, } x = \frac{5000 \times 10^{-10} \times 1000}{0.1} = 5 \times 10^{-3} \text{ m} = 5 \text{ mm}$$

82 Diameter of human eye lens is 2 mm. What will be the minimum distance between two points to resolve them, which are situated at a distance of 50 m from eye? [The wavelength of light is 5000 Å] [CBSE AIPMT 2002]

- (a) 2.32 m (b) 4.28 mm
 (c) 1.25 cm (d) 12.48 cm

Ans. (c)

Angular limit of resolution of eye
 $= \frac{\text{wavelength of light}}{\text{diameter of eye lens}}$

$$\text{i.e. } \theta = \frac{\lambda}{d} \quad \dots(i)$$

If y is the minimum distance between two points at distance D from eye, then
 Angular limit of resolution of eye

$$\theta = \frac{y}{D} \quad \dots(ii)$$

From Eqs. (i) and (ii), we have

$$\frac{y}{D} = \frac{\lambda}{d}$$

$$\text{or } y = \frac{\lambda D}{d} \quad \dots(iii)$$

Given, $\lambda = 5000 \text{ \AA} = 5 \times 10^{-7} \text{ m}$, $D = 50 \text{ m}$,
 $d = 2 \text{ mm} = 2 \times 10^{-3} \text{ m}$

Substituting in Eq. (iii), we get

$$y = \frac{5 \times 10^{-7} \times 50}{2 \times 10^{-3}} = 12.5 \times 10^{-3} \text{ m} = 1.25 \text{ cm}$$

83 An astronomical telescope of ten-fold angular magnification has a length of 44 cm. The focal length of the objective is [CBSE AIPMT 1997]

- (a) 440 cm (b) 44 cm
 (c) 40 cm (d) 4 cm

Ans. (c)

For an astronomical telescope,

where magnification, $m = \frac{f_o}{f_e}$

f_o = focal length of objective lens

f_e = focal length of eye piece lens

Length of telescope tube $L = f_o + f_e$

Given, $m = 10$, $L = 44 \text{ cm}$

$$\therefore \frac{f_o}{f_e} = 10$$

$$\text{and } f_o + f_e = 44$$

$$\Rightarrow f_e = \frac{f_o}{10}$$

$$\text{So, } f_o + \frac{f_o}{10} = 44$$

$$\text{or } \frac{11f_o}{10} = 44$$

$$\text{or } f_o = 40 \text{ cm}$$

84 The hypermetropia is a [CBSE AIPMT 1995]

- (a) short-sight defect
 (b) long-sight defect
 (c) bad vision due to old age
 (d) None of the above

Ans. (b)

A hypermetropic person or a long sighted person can see clearly only those objects which are at long distances, as if near point of his eye has shifted to some distant point. This defect arises on account of contraction of eye ball or increase in focal length of eye lens. To correct this defect, the person has to wear specs using a convex lens of suitable focal length given by

$$\frac{1}{f} = \frac{1}{D} - \frac{1}{d}$$

where d = actual distance of distinct vision of defective eye, and

D = distance of distinct vision of normal eye.

Note A myopic person can see clearly only those objects which are at short distances from the eye. This is as if far point of the eye has shifted to some nearby point.

Oldage vision defect is also called astigmatism. It arises because curvature of the cornea plus eye lens refracting system is not the same in different planes. This defect is removed by using a cylindrical lens with its axis along the vertical.